

ACİL BARINMA YAPISI

İMALAT KILAVUZU

YAPI ELEMANLARININ KAPLAMA, TAŞIYICI VE ISI YALITIMI DETAYLARI
YAPININ TAŞIYICI PARÇALARININ ÖLÇÜLERİ, KESİM VE BİRLEŞİM DETAYLARI

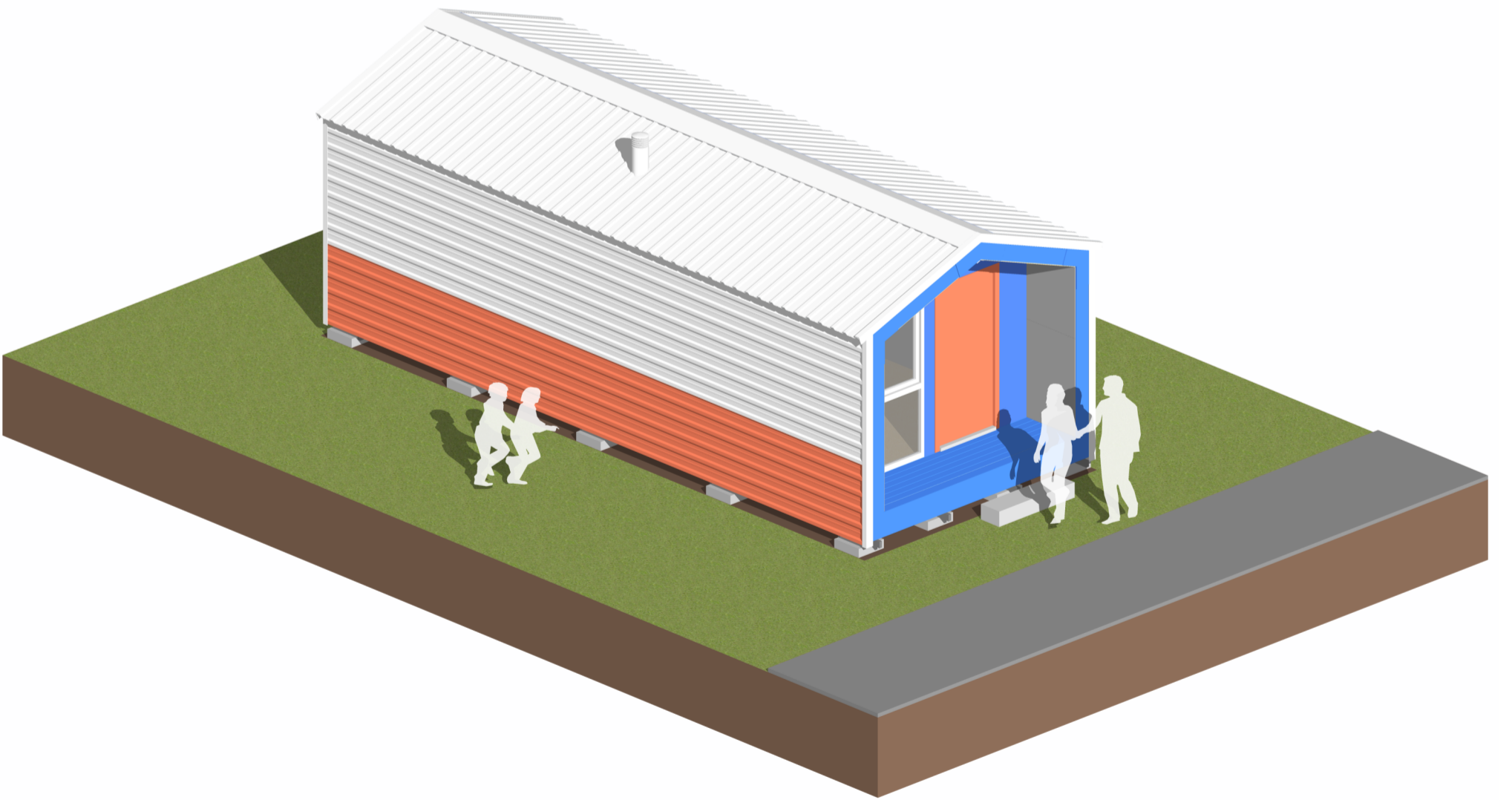

V1

HAZIR ZEMİN PANELLERİ (HZ)

OSB 11mm + 4,4cm x x4,4cm Kereste + Taşyünü Levha + OSB 18mm

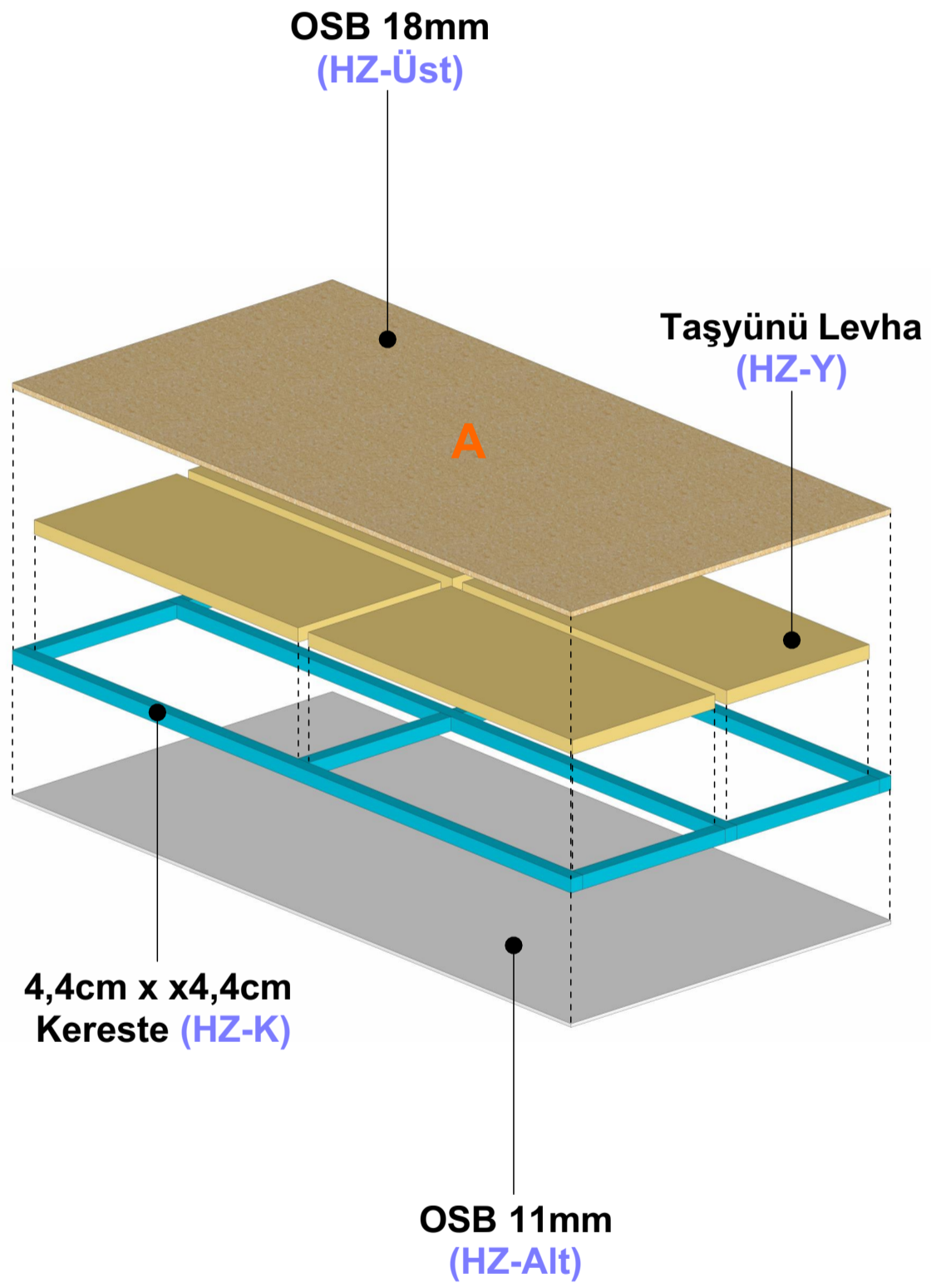
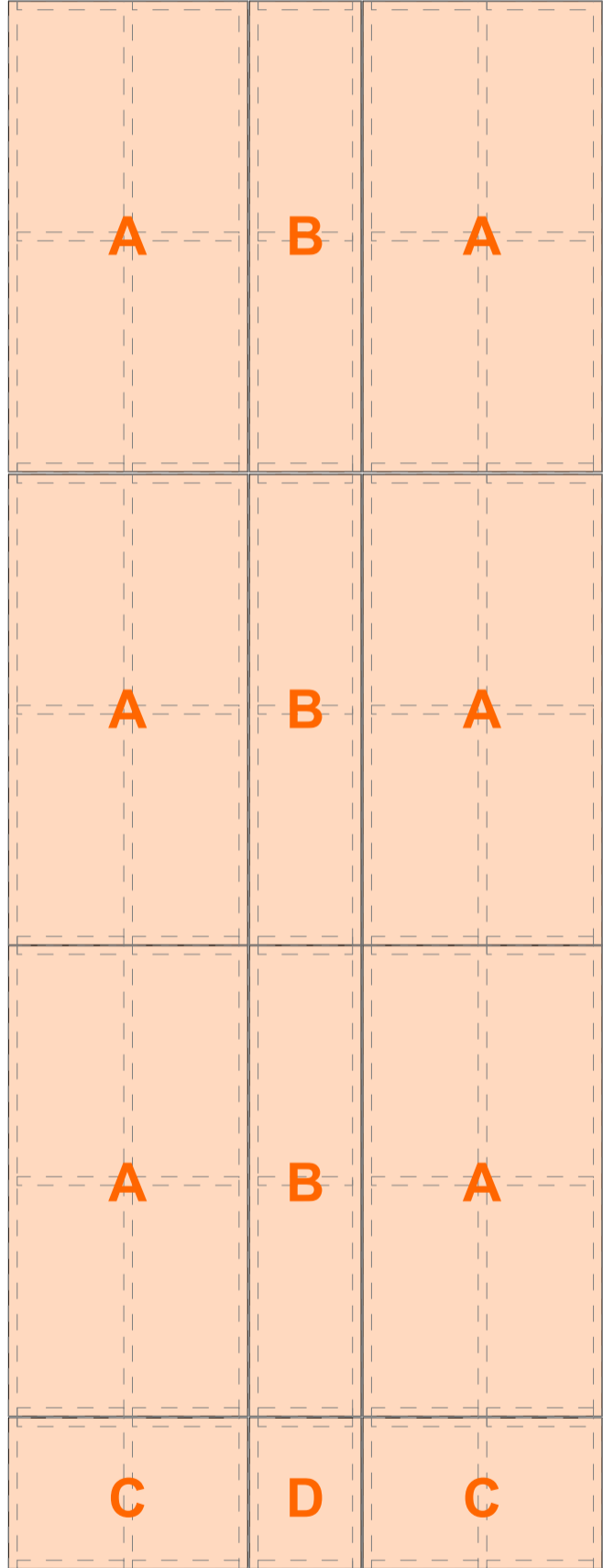

HAZIR ZEMİN PANELLERİ (ALT KAPLAMA)

(HZ-O Alt)

OSB 11mm

HZ-O Alt 1 (A)	 (B) HZ-O Alt 2	HZ-O Alt 1 (A)
HZ-O Alt 1 (A)	 (B) HZ-O Alt 2	HZ-O Alt 1 (A)
HZ-O Alt 1 (A)	 (B) HZ-O Alt 2	HZ-O Alt 1 (A)
(C) HZ-O Alt 3	(D) HZ-O Alt 4	(C) HZ-O Alt 3

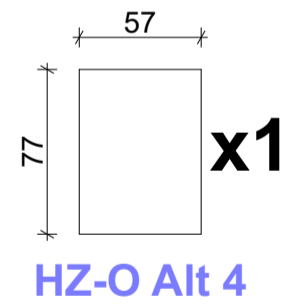
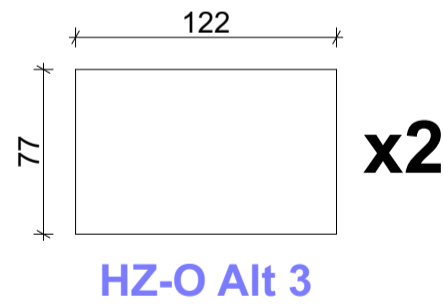
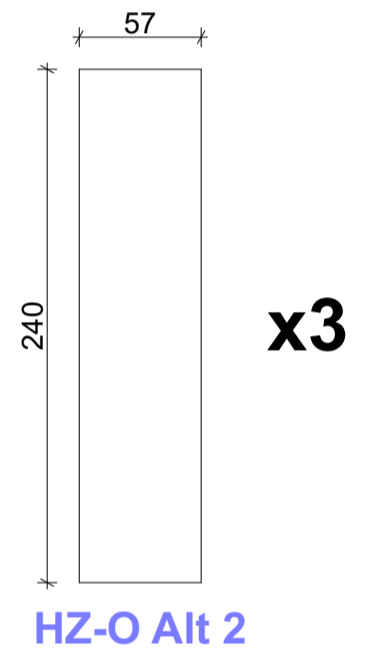
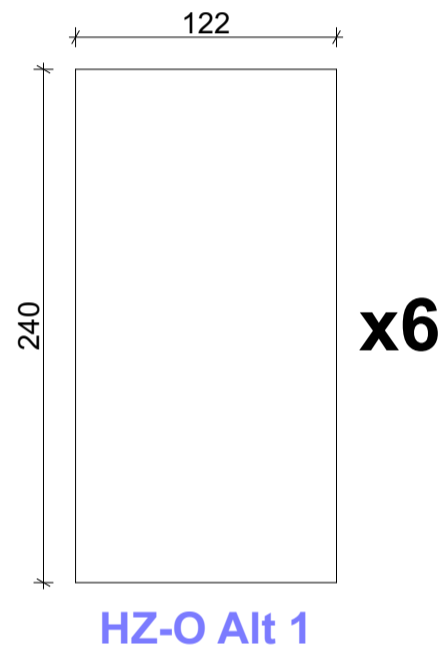

ÖN CEPHE

HAZIR ZEMİN PANELLERİ (TAŞIYICI İSKELET)

(HZ-K)

4,4cm x 4,4cm Kereste (HZ-K)

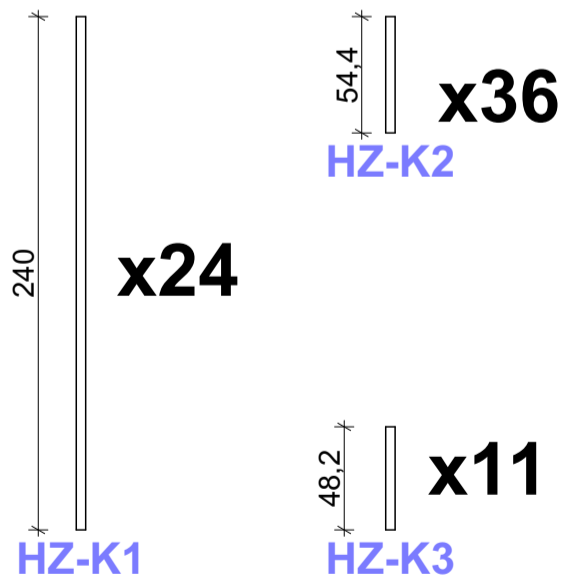
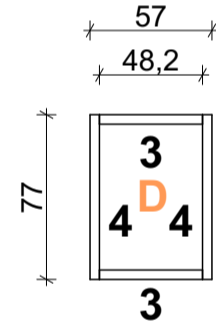
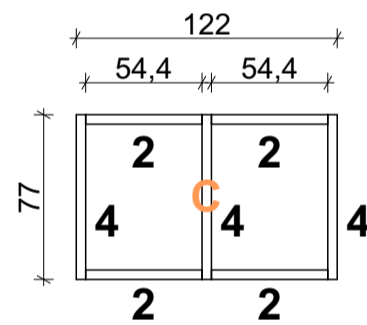
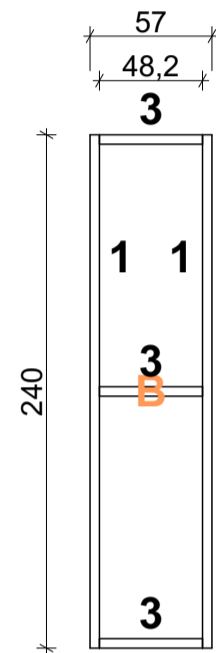
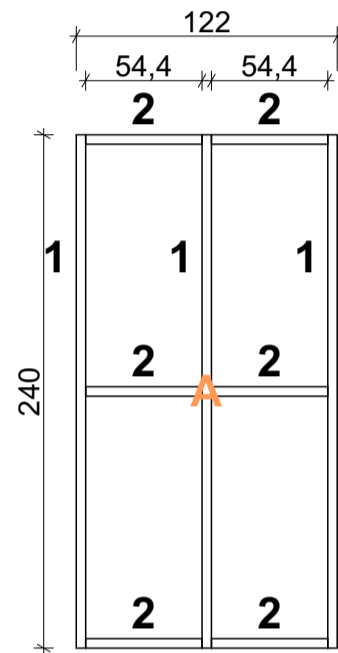
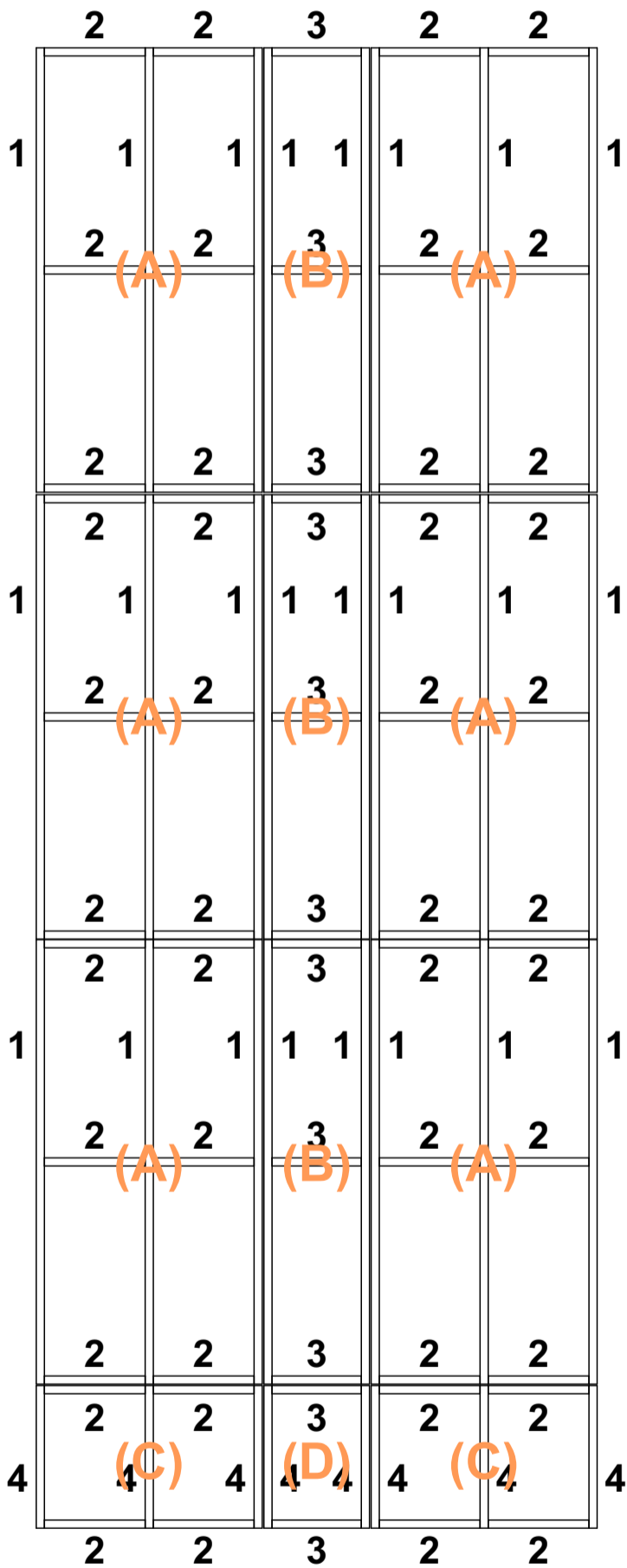

HAZIR ZEMİN PANELLERİ (ISI YALITIMI)

(HZ-Y)

Taşıyünü Levha (HZ-Y)

1 (A)	1	2 (B)	1 (A)	1
1	1	2	1	1
1 (A)	1	2 (B)	1 (A)	1
1	1	2	1	1
1 (A)	1	2 (B)	1 (A)	1
1	1	2	1	1
3 (C)	3	4 (D)	3 (C)	3

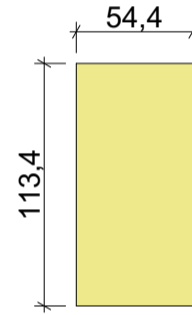

HZ-Y1

x24

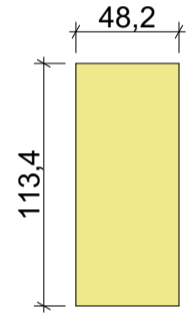

HZ-Y2

x6

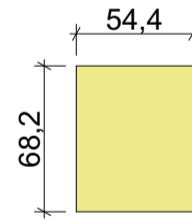

HZ-Y3

x4

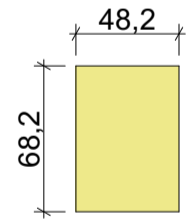

HZ-Y4

x1

Taşıyünü (Zemin) Alan:

19,90 m²

HAZIR ZEMİN PANELLERİ (ÜST KAPLAMA)

(HZ-O Üst)

OSB 18mm (HZ-Üst)

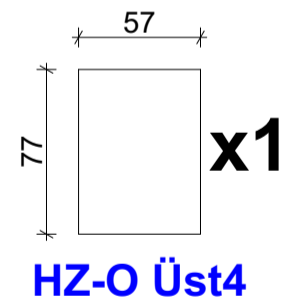
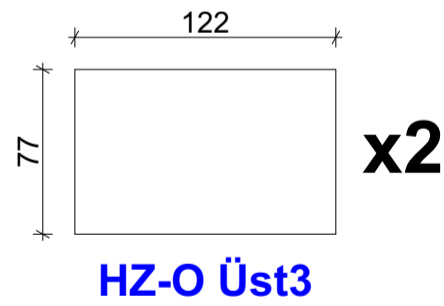
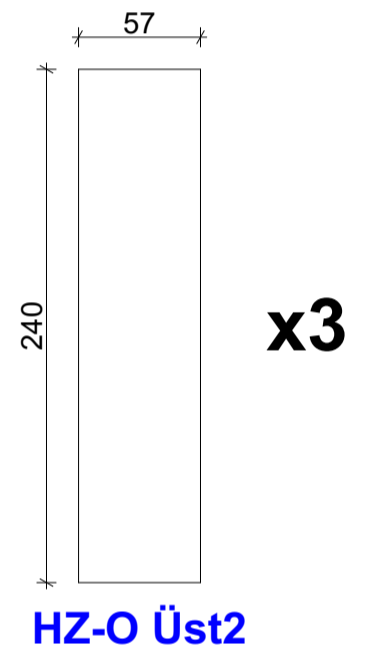
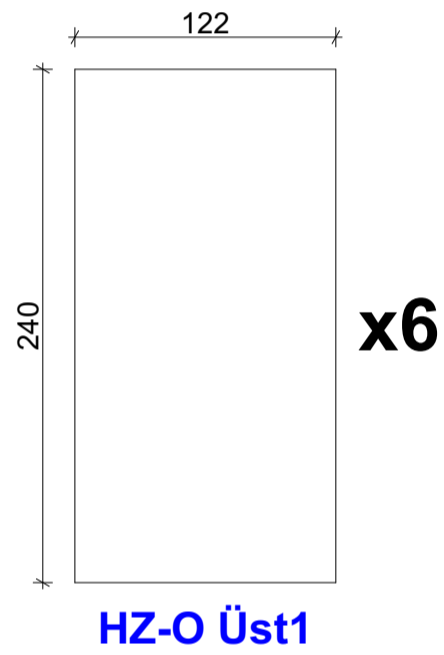
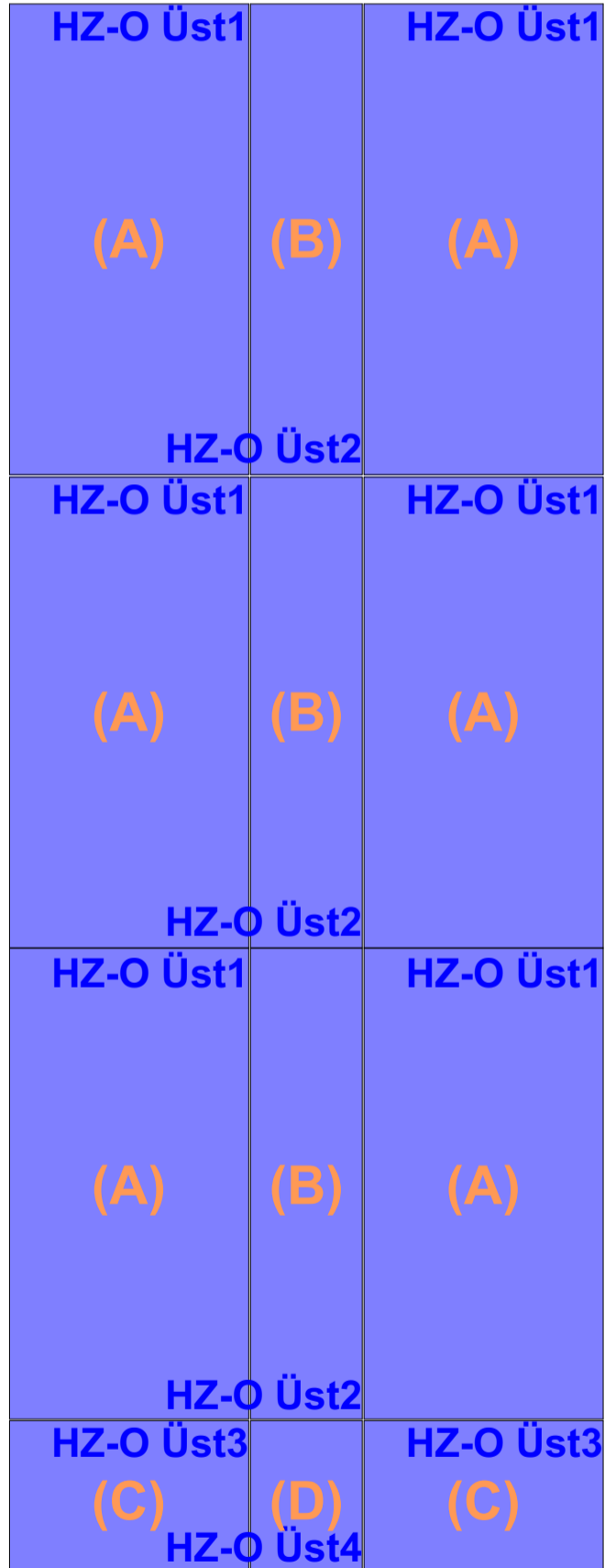

ÖN CEPHE

4,4cm x 4,4cm Kereste

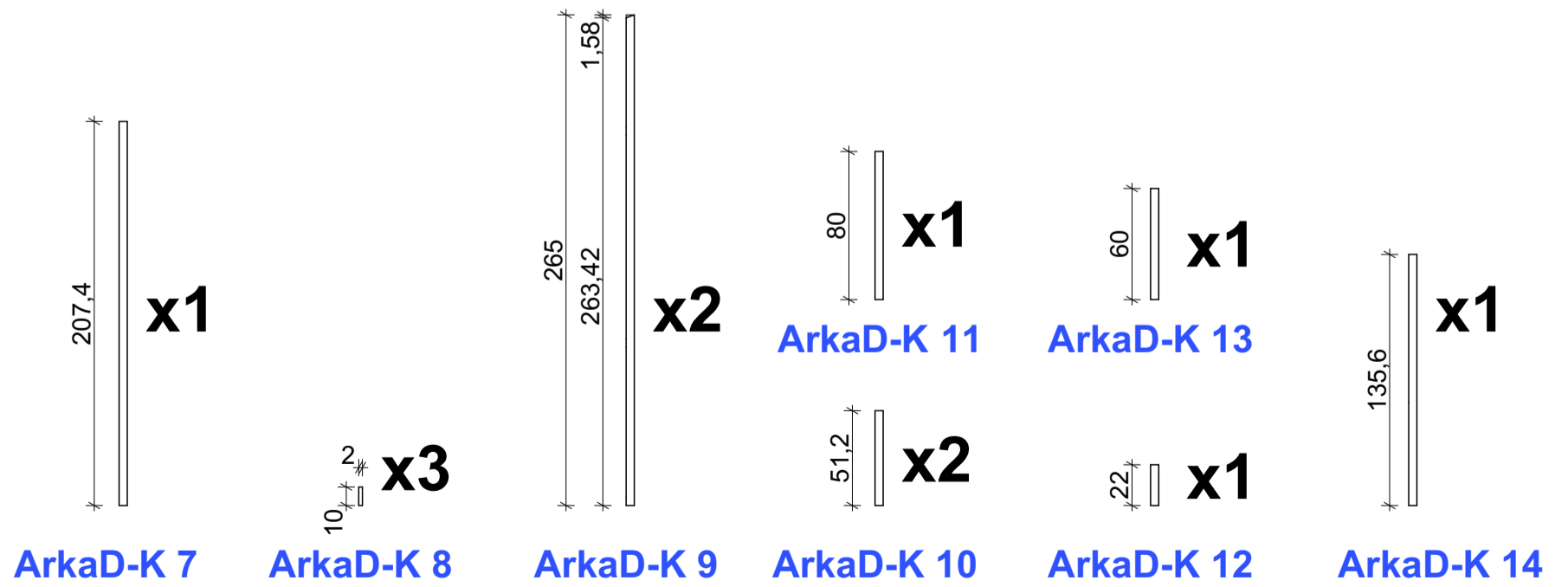
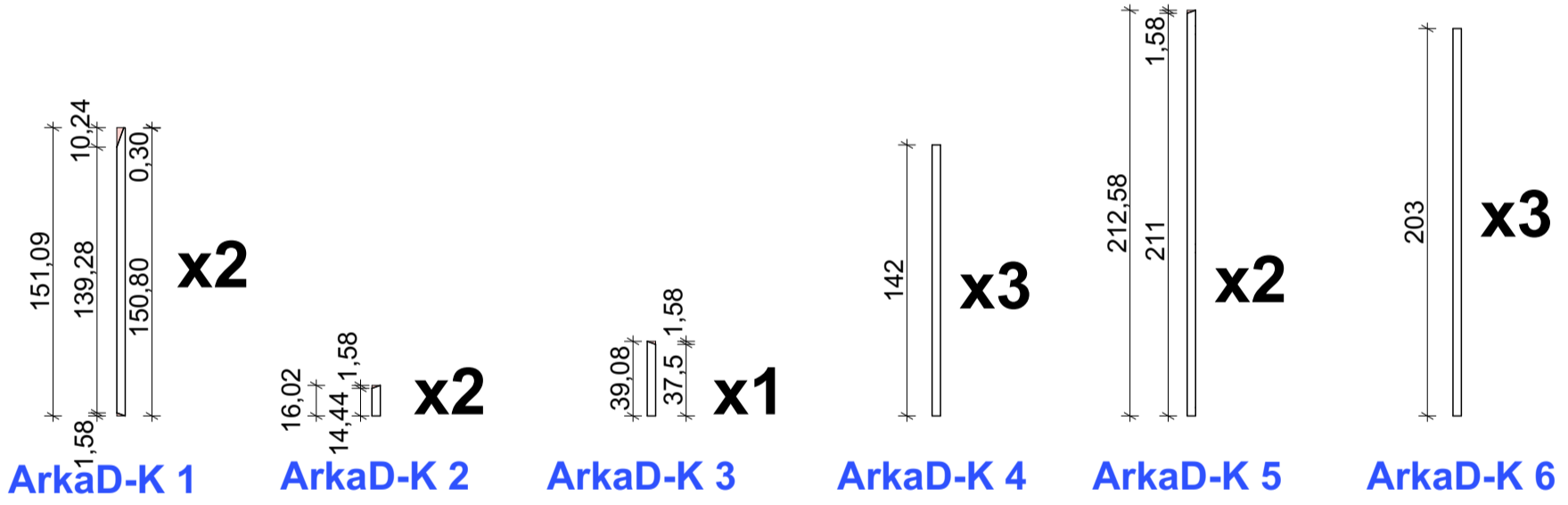
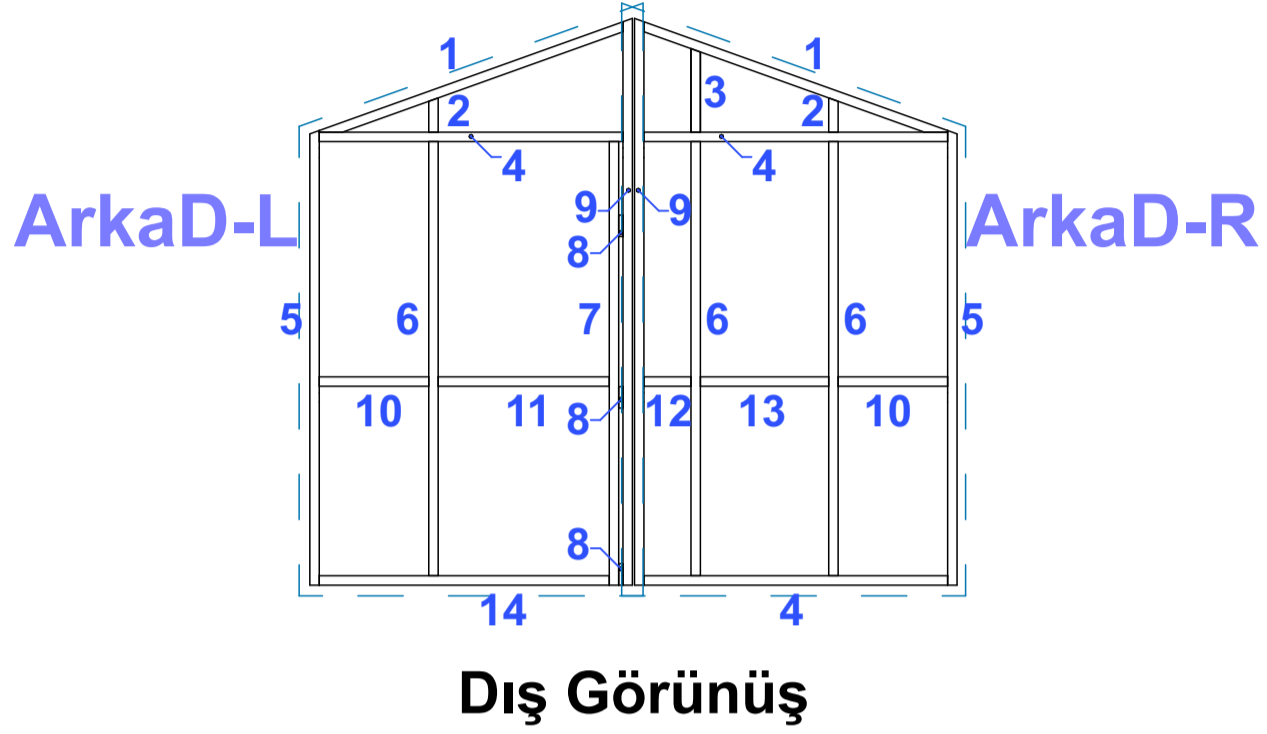

OSB 11mm

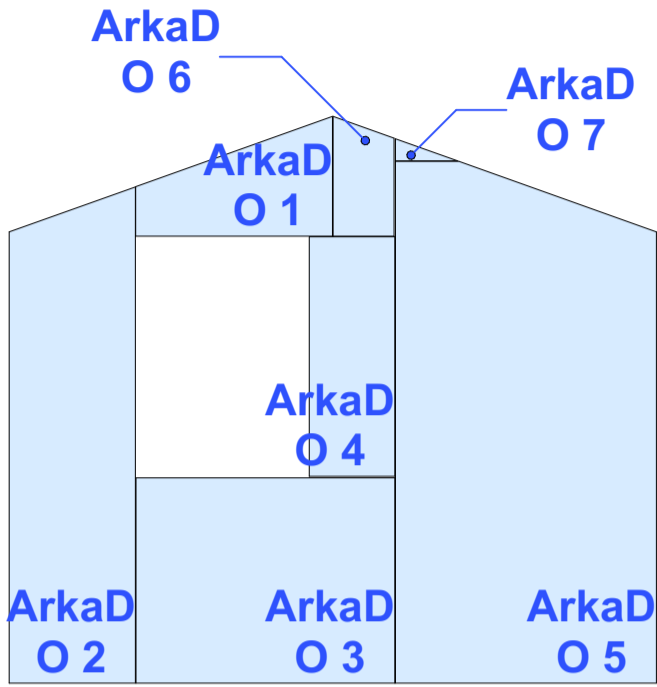

Dış Görünüş

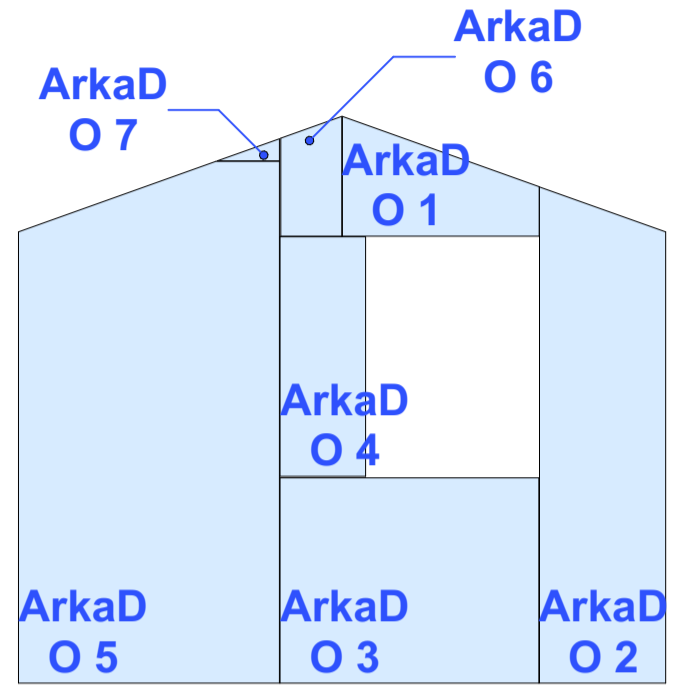

İç Görünüş

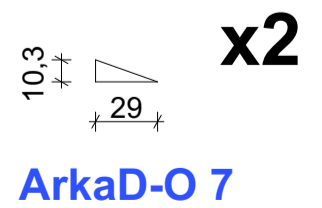
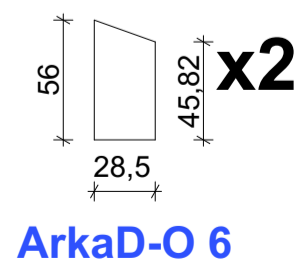
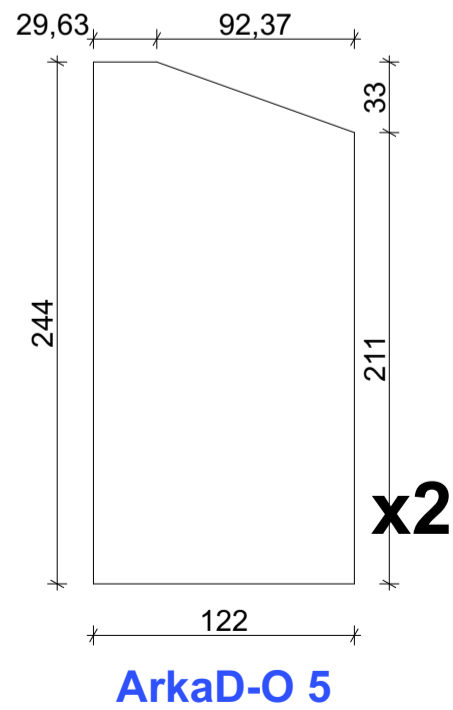
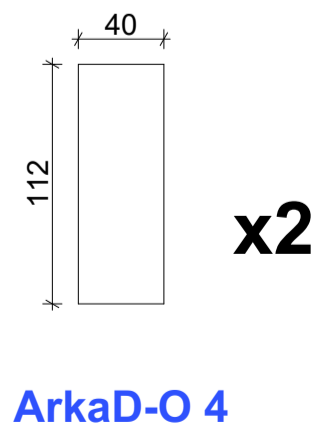
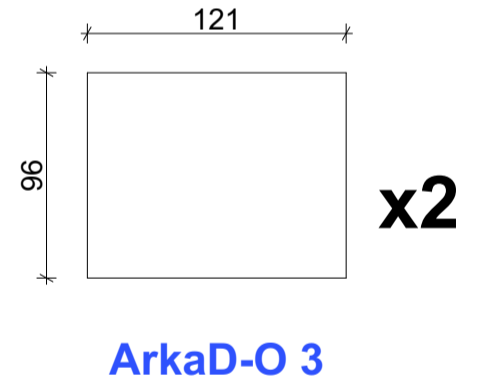
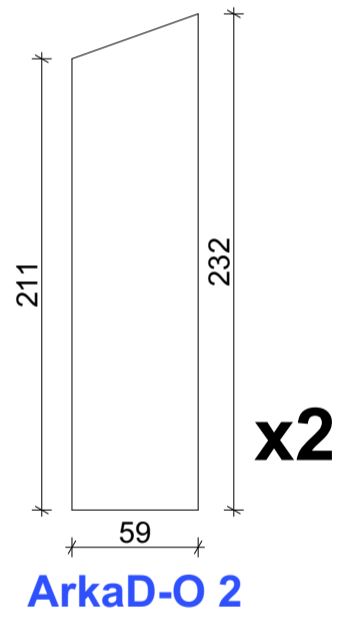
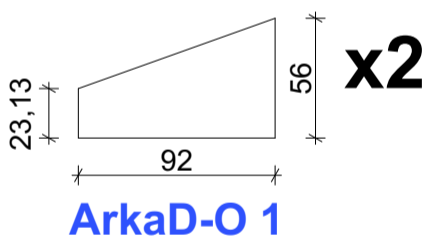

4,4cm x 4,4cm Kereste

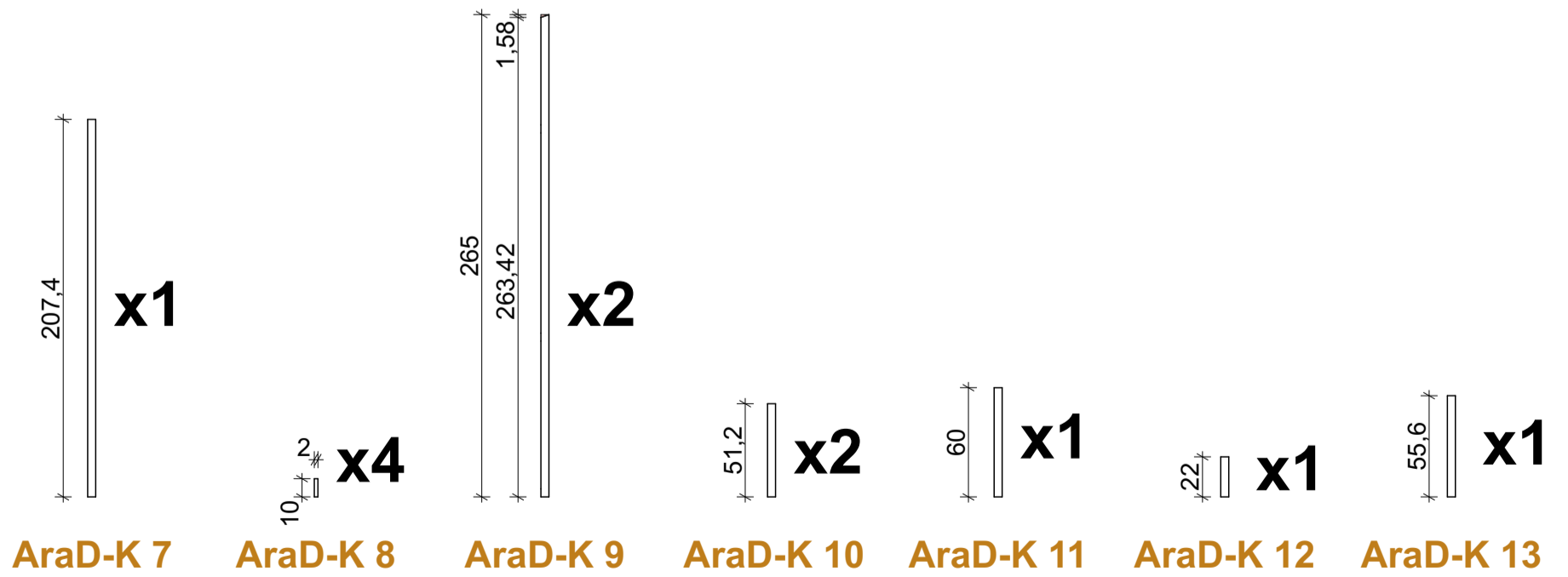
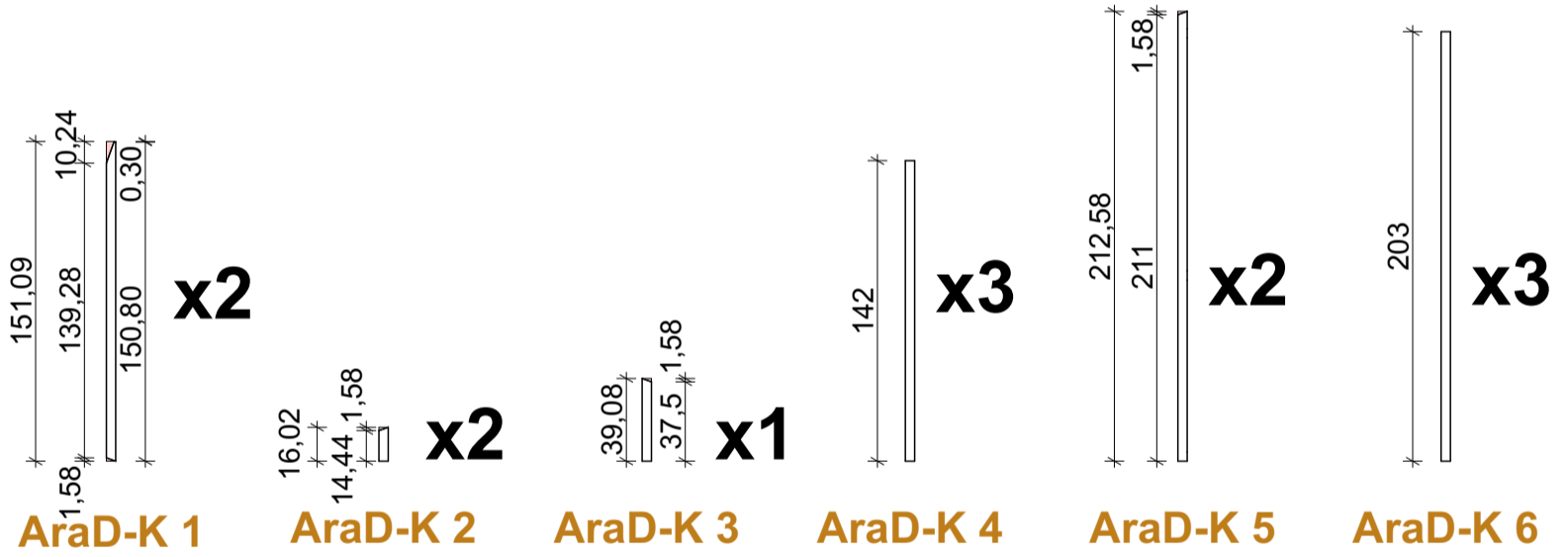
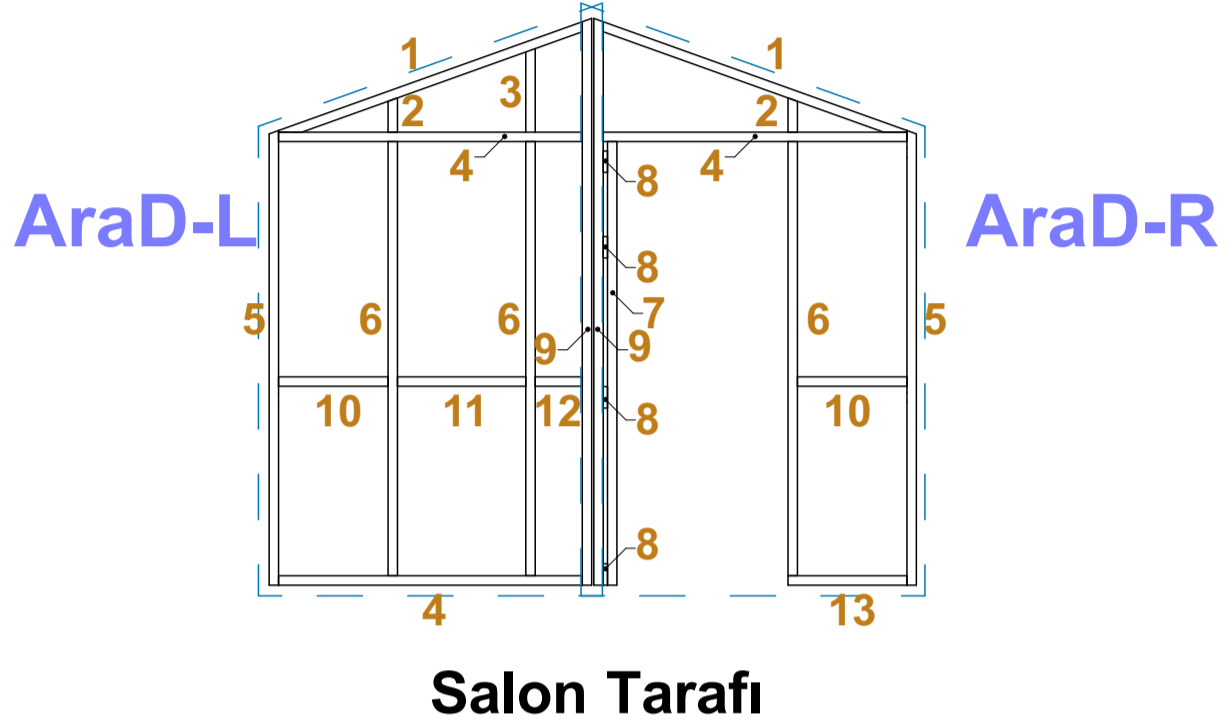

OSB 11mm

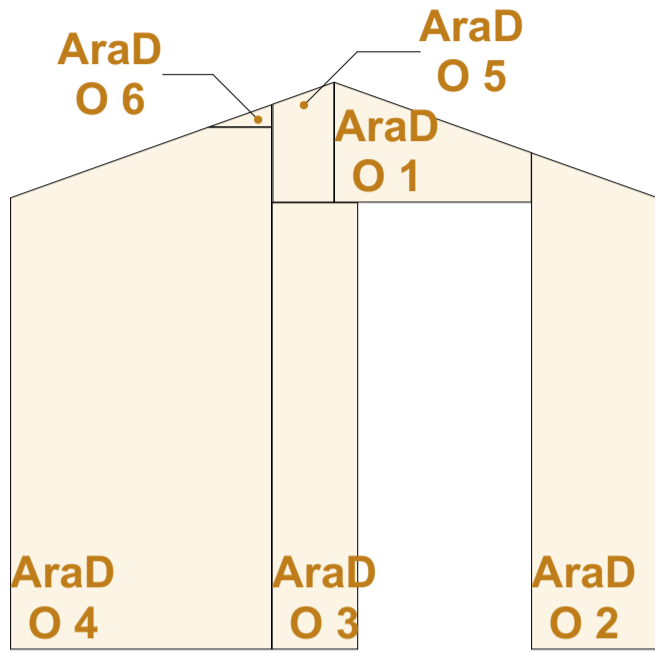

Salon Tarafı

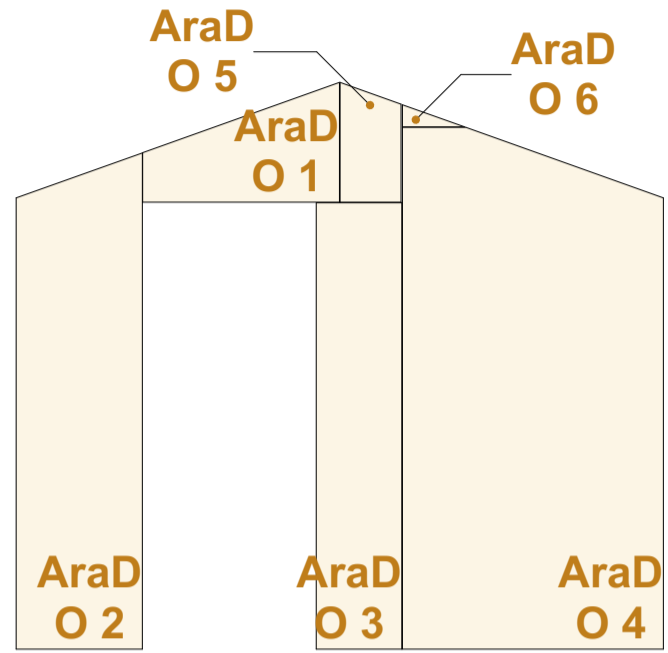

Oda Tarafı

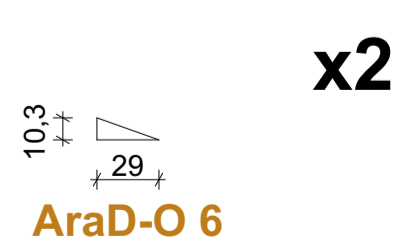
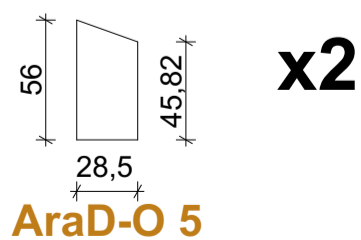
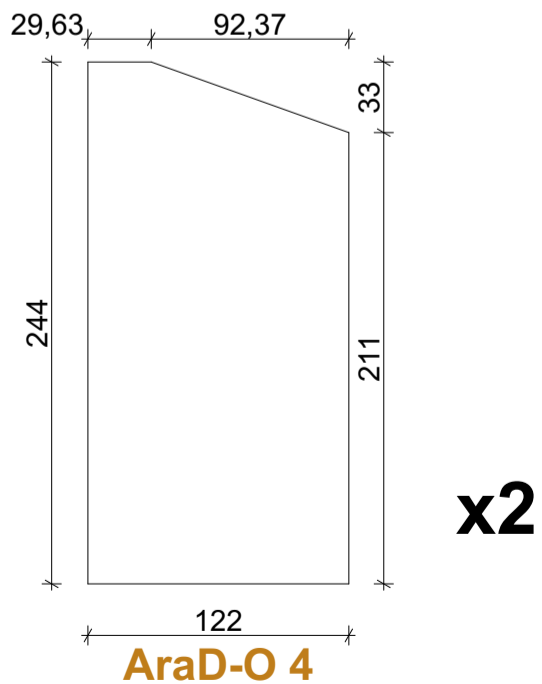
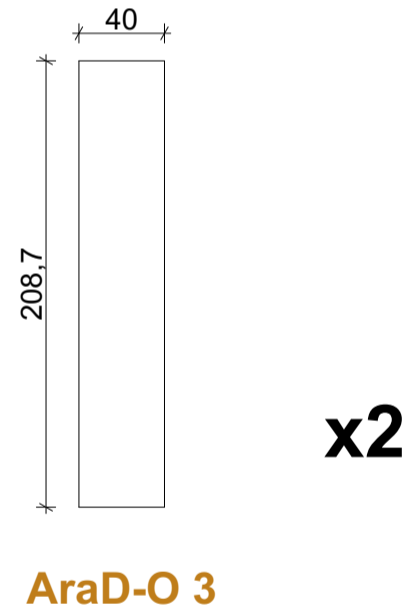
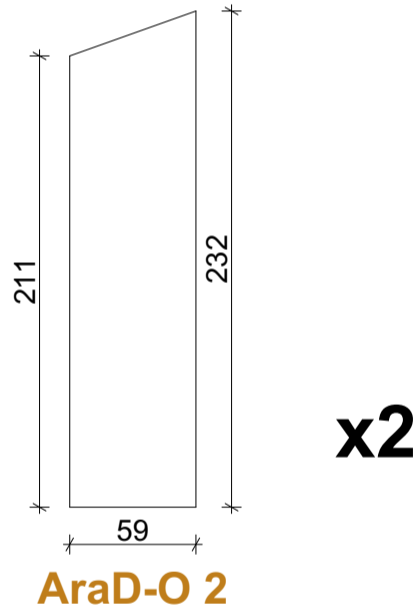
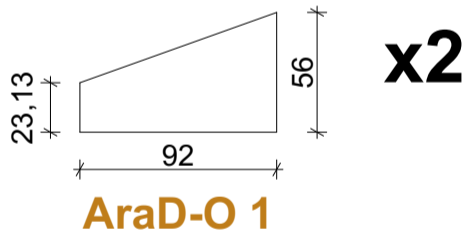

BANYO DUVARLARI / Taşıyıcılar

(BD-K)

4,4cm x 4,4cm Kereste

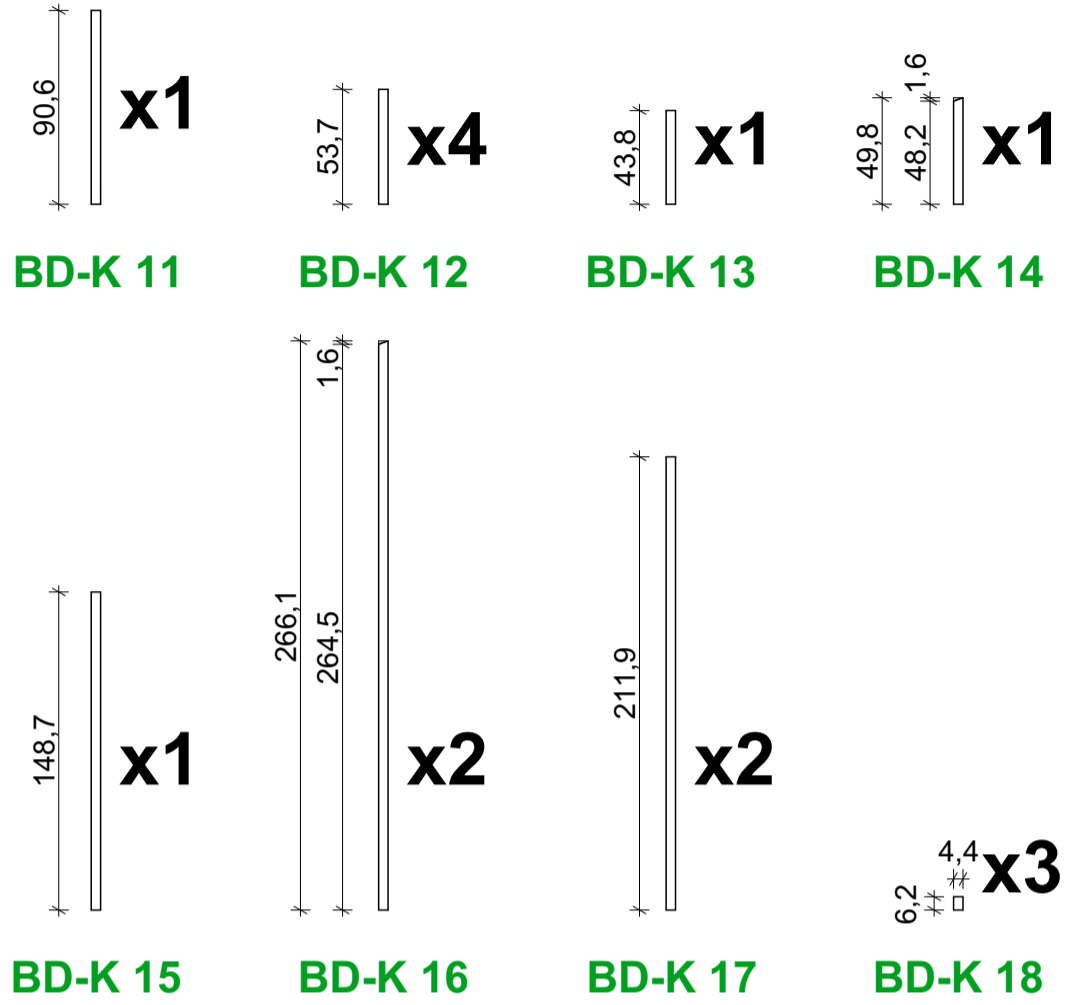
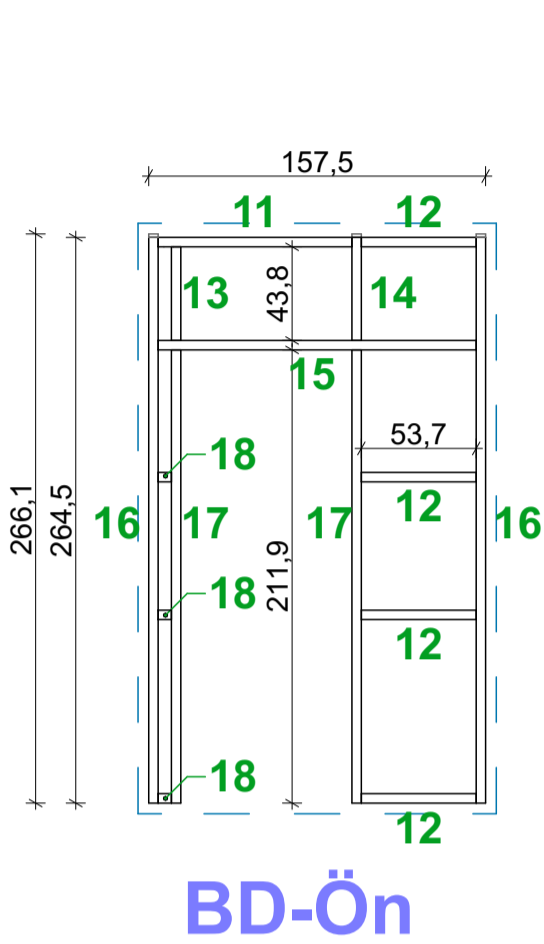

Banyo Giriş Duvar Paneli (Banyo Dışından)

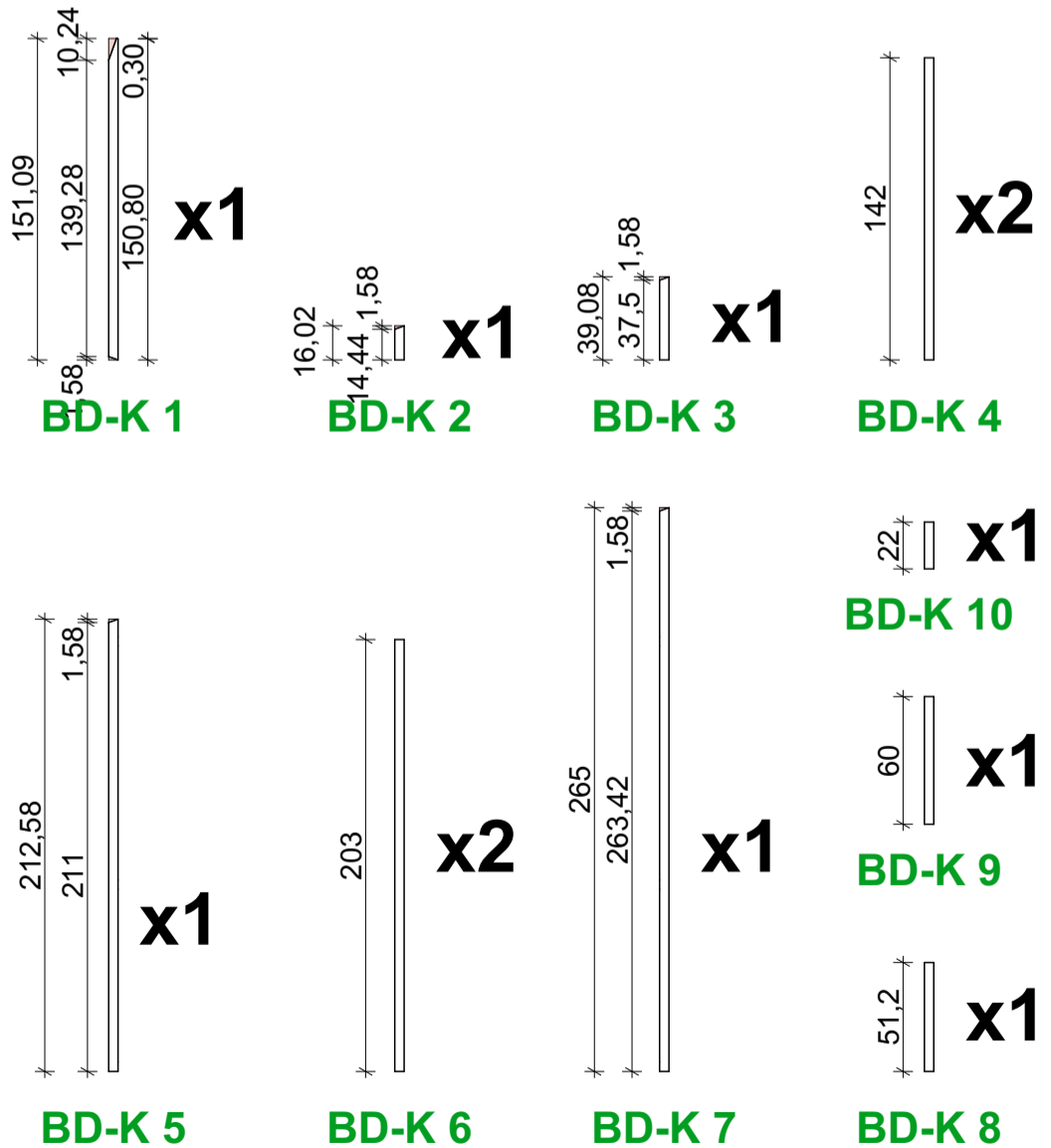
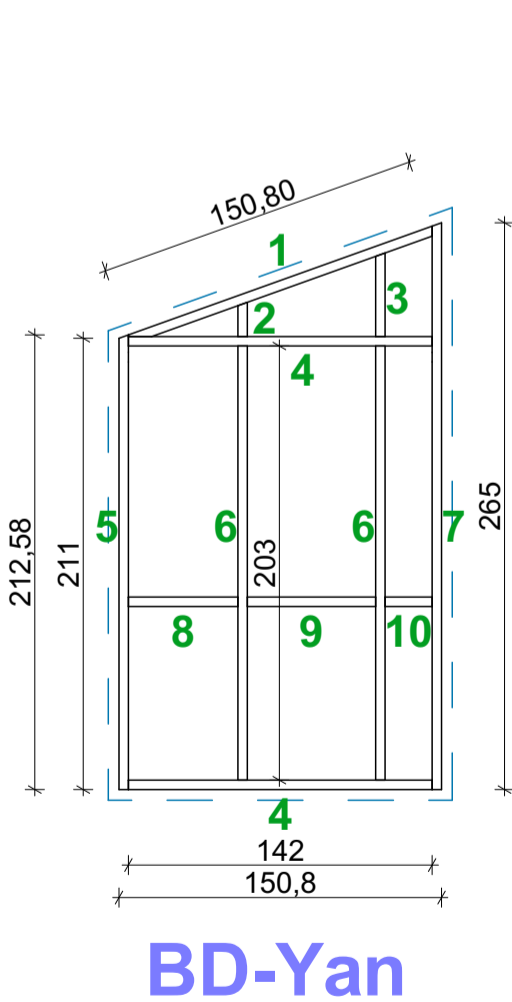

Banyo Yan Duvar Paneli (Banyo Dışından)

OSB 11mm

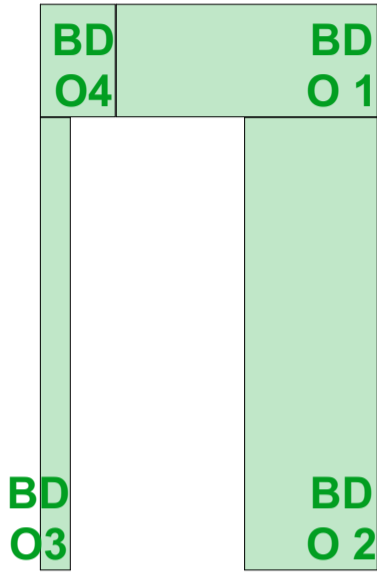

Banyo Dışı

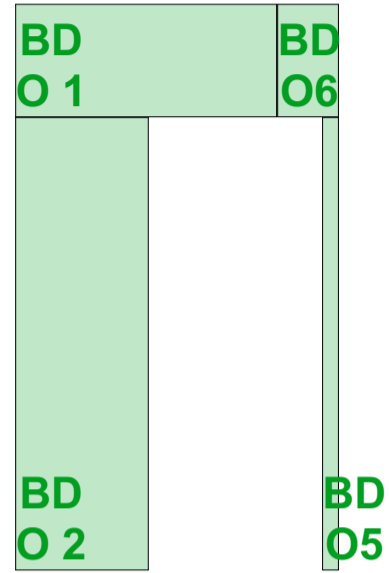

Banyo İçi

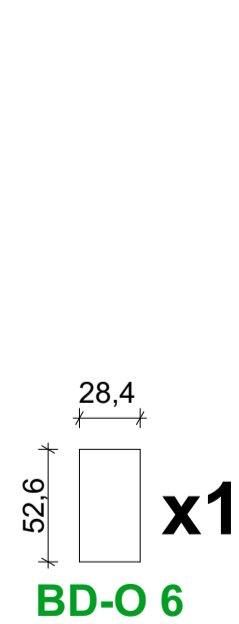
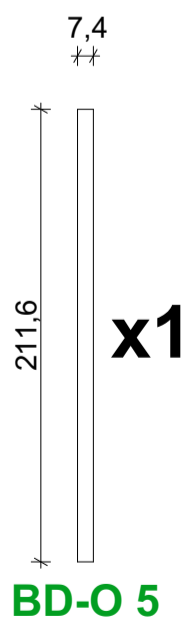
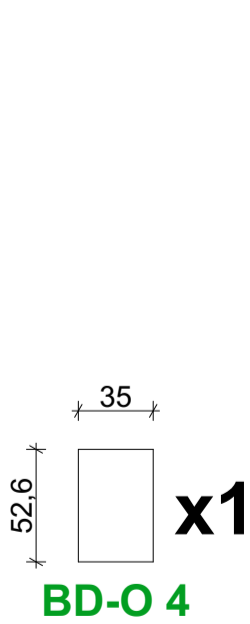
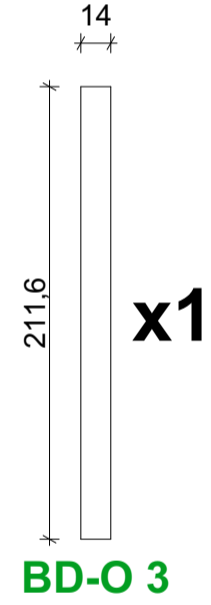
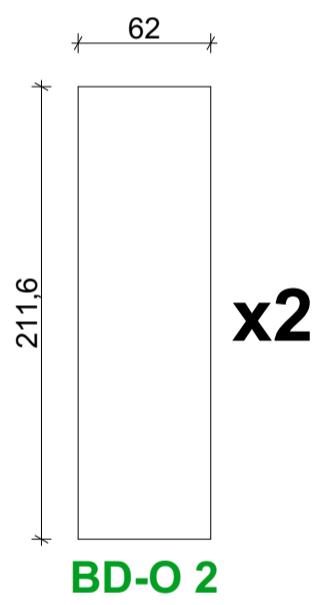
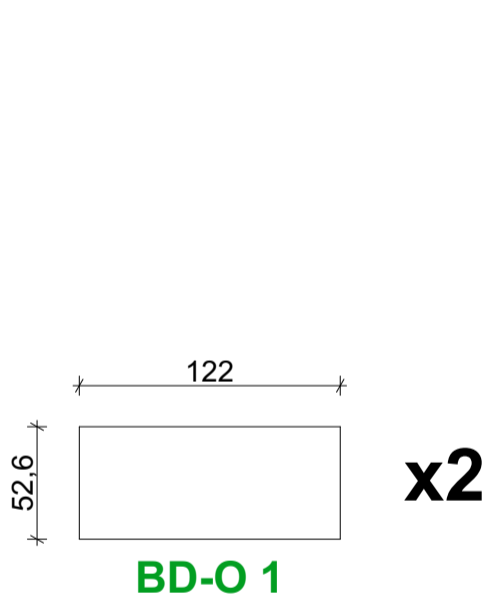

OSB 11mm

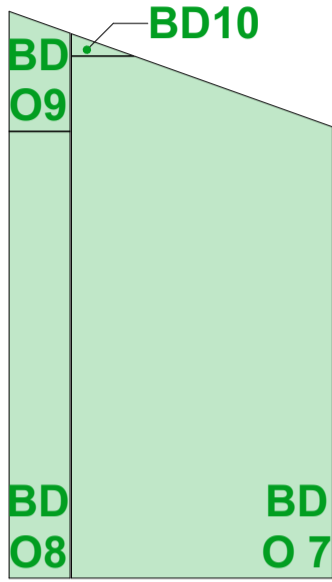

Banyo İçi

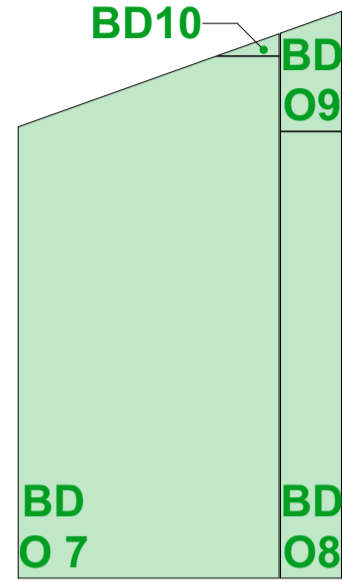

Banyo Dışı

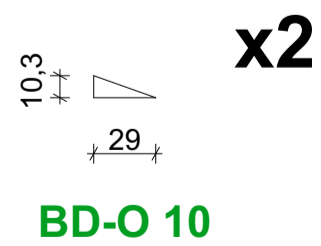
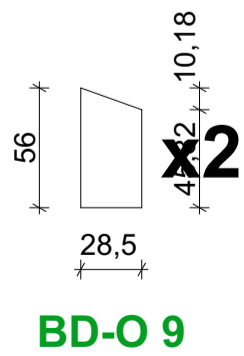
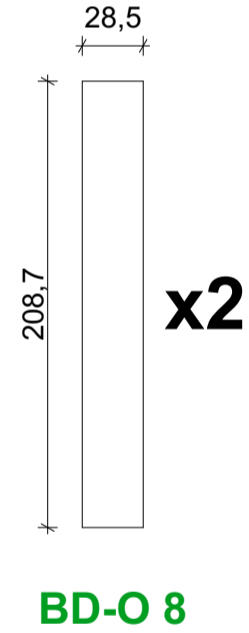
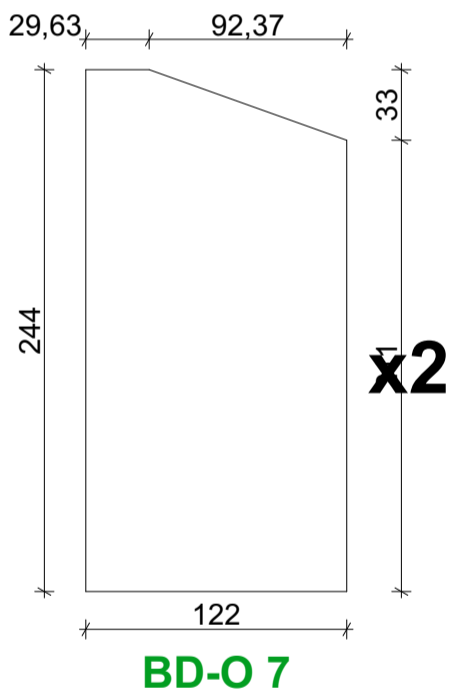

ÖN DUVAR / Taşıyıcılar

(ÖD-K)

4,4cm x 4,4cm Kereste

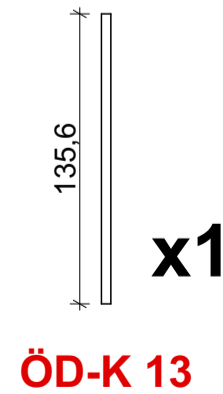
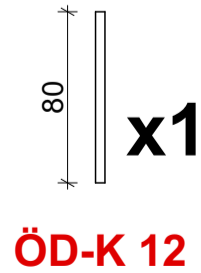
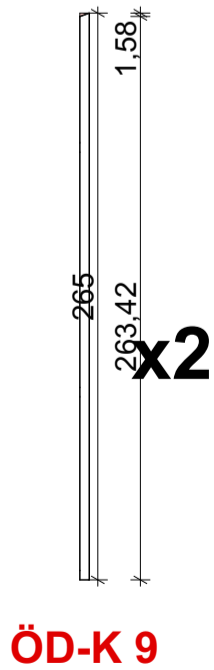
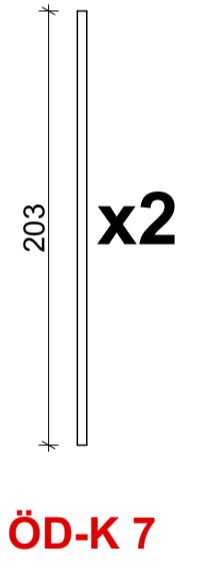
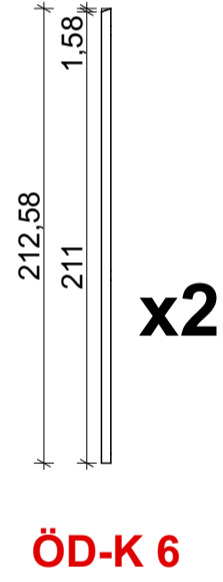
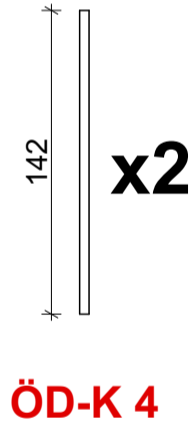
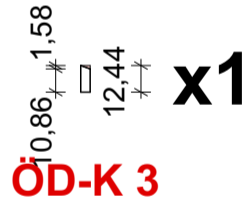
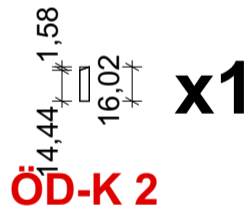
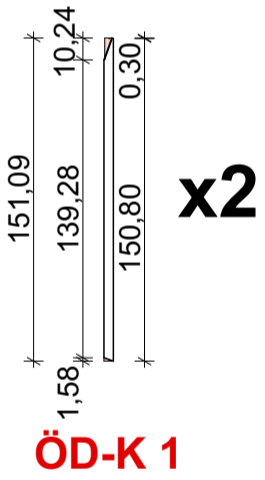
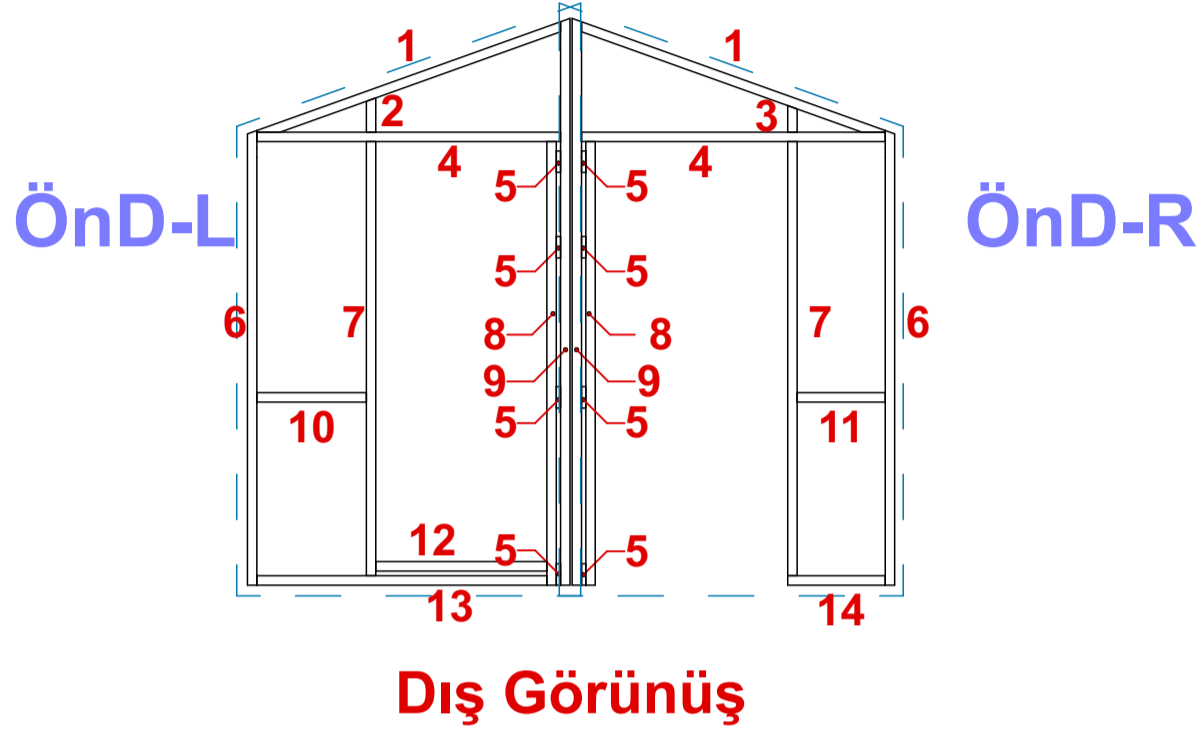

OSB 11mm

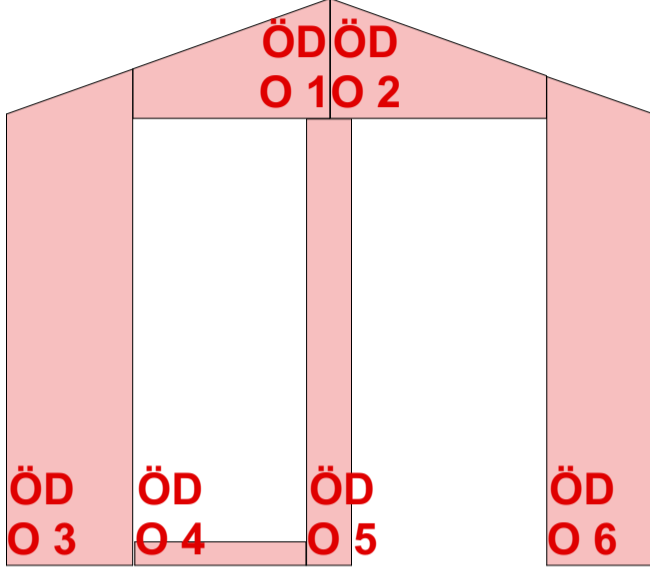

Dış Görünüş

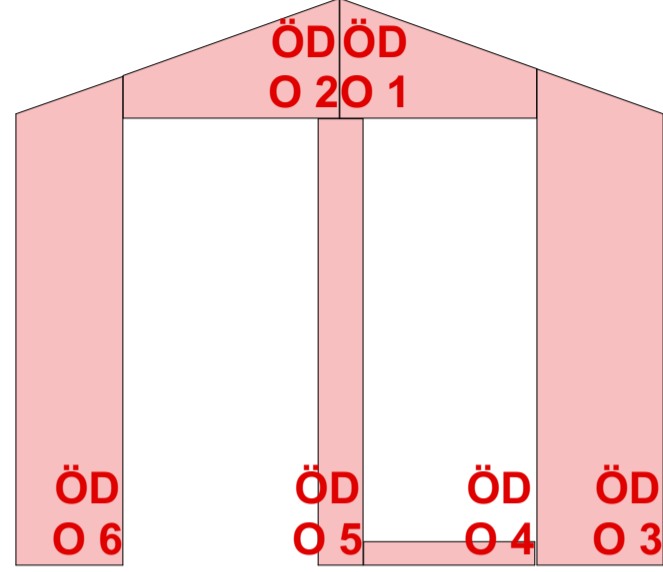

İç Görünüş

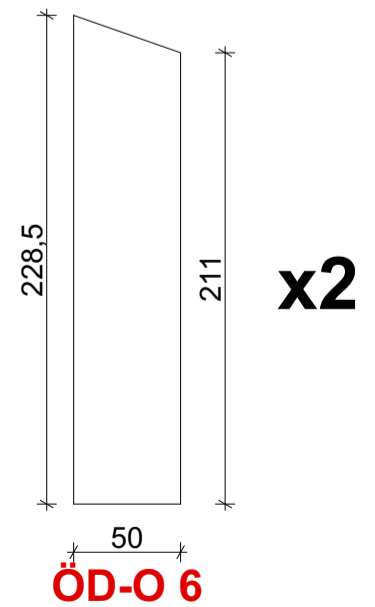
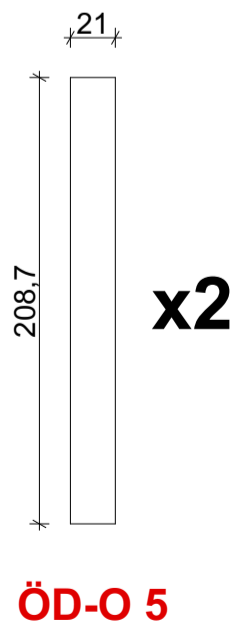
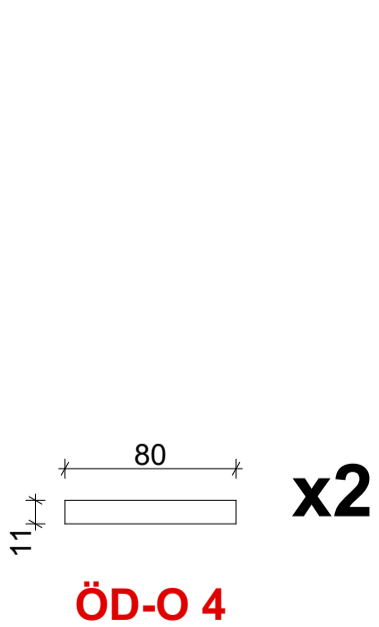
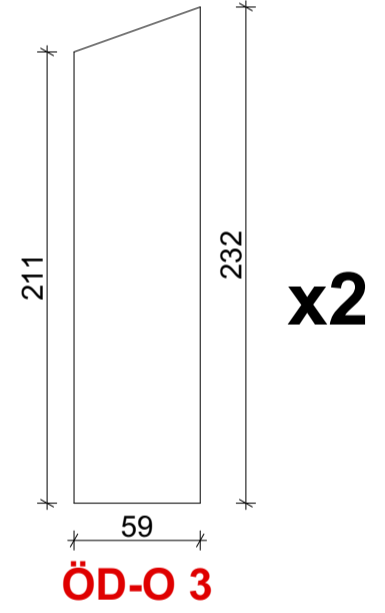
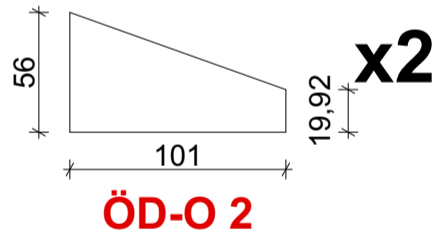
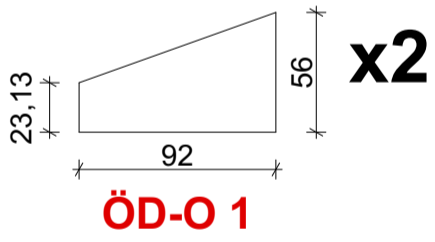

İÇ YAN DUVAR KAPLAMA (SOL)

(YD-O)

OSB 11mm

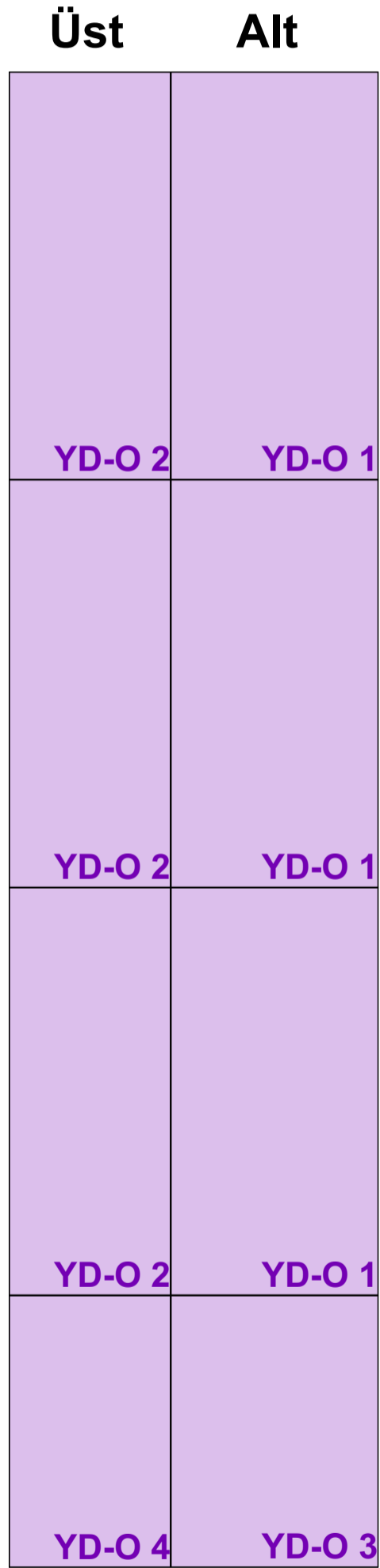

ÖN CEPHE

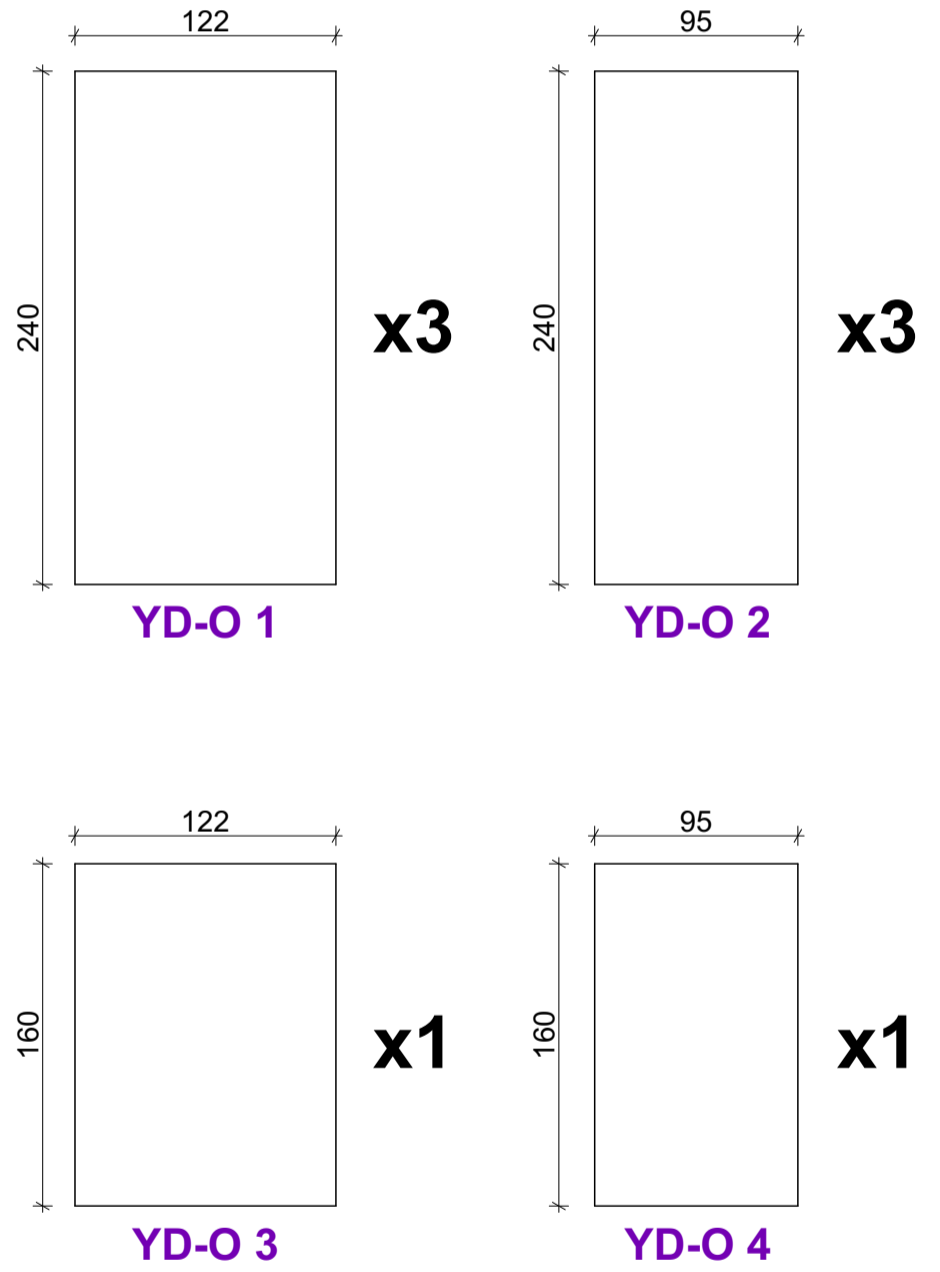

İÇ YAN DUVAR KAPLAMA (SAĞ)

(YD-O)

OSB 11mm

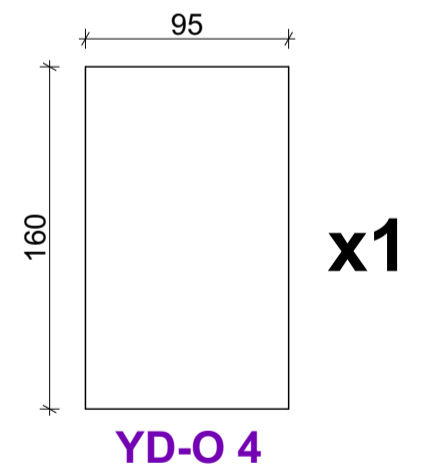
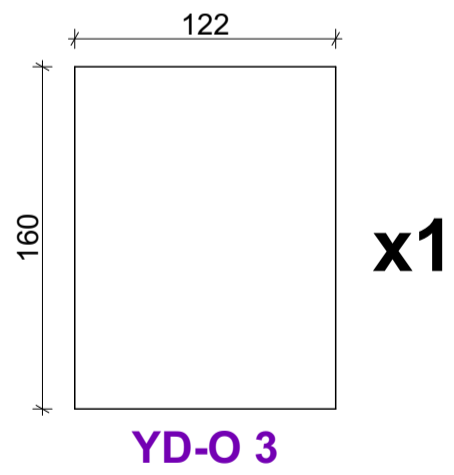
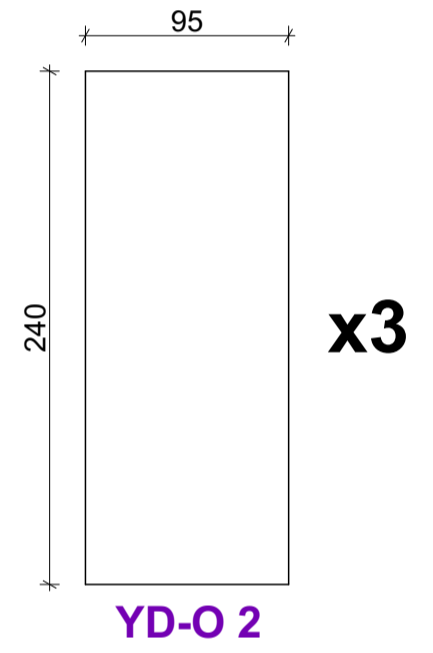
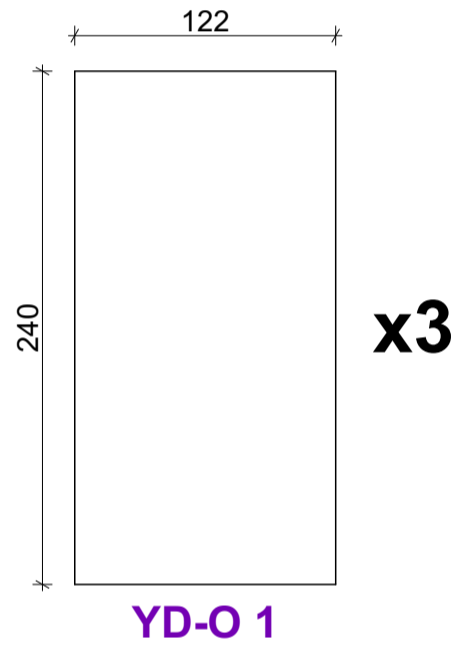
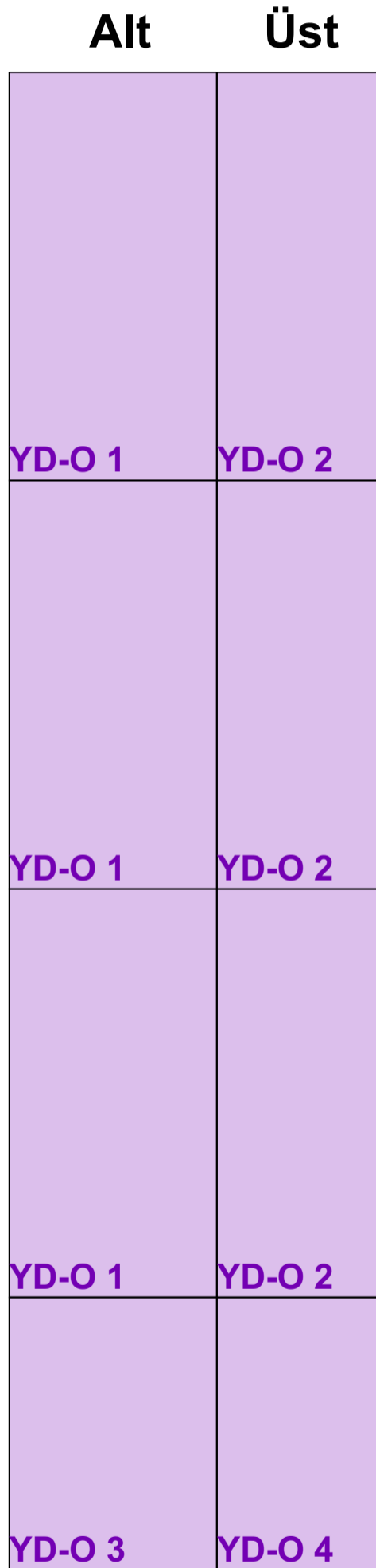

ÖN CEPHE

İÇ TAVAN KAPLAMA

(T-O)

OSB 11mm

T 01	T 01
T 01	T 01
T 01	T 01
T 01	T 01
T 01	T 01
T 01	T 01
T 01	T 01
T 01	T 01
T 01	T 01
T 01	T 01
T 01	T 01
T 01	T 01
T 01	T 01
T 01	T 01
T 01	T 01

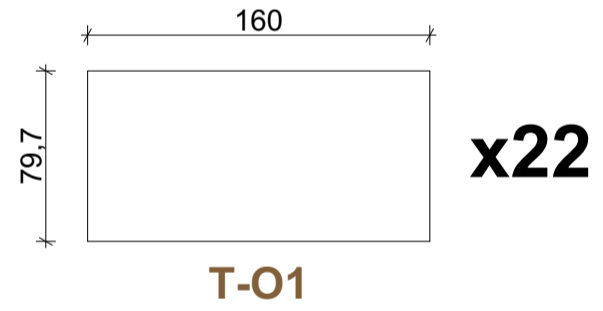

ÖN CEPHE

SAC ÇATI ve CEPHE KAPLAMALARI

Trapez 0,50mm

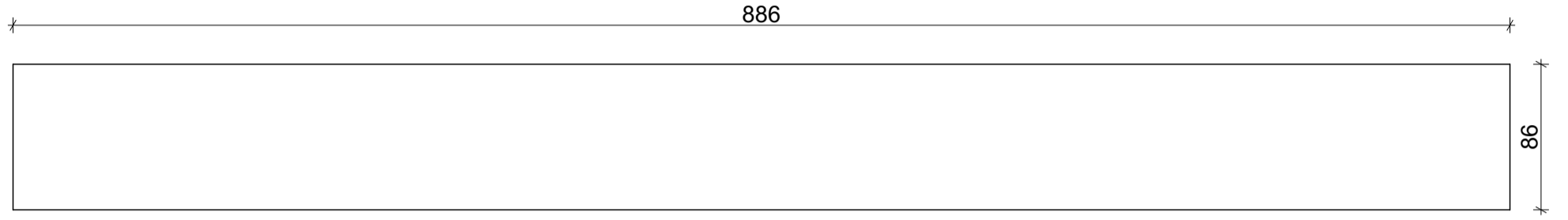

x6

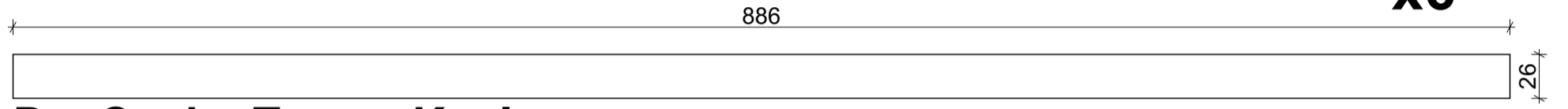

x2

Dış Cephe Trapez Kaplama

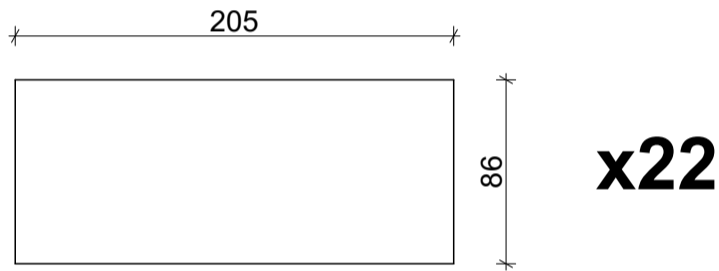

Çatı Trapez Kaplama

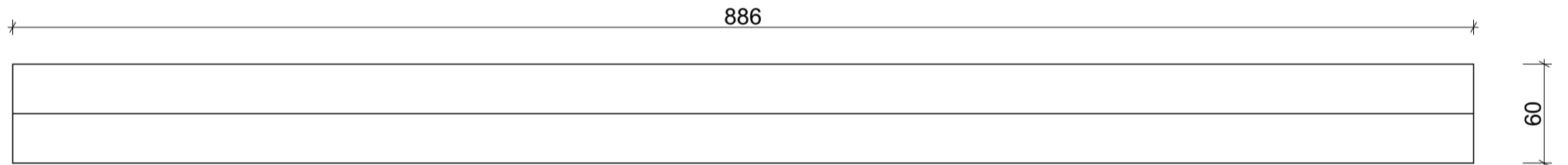

x1

Sac Mahya



Çatı Trapez Sac Altı Tahtalar

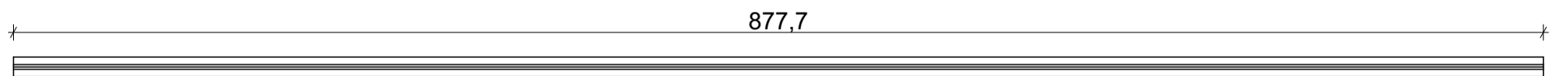

Ters Mahya

x1

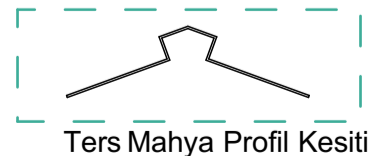

SAC AKSESUARLAR

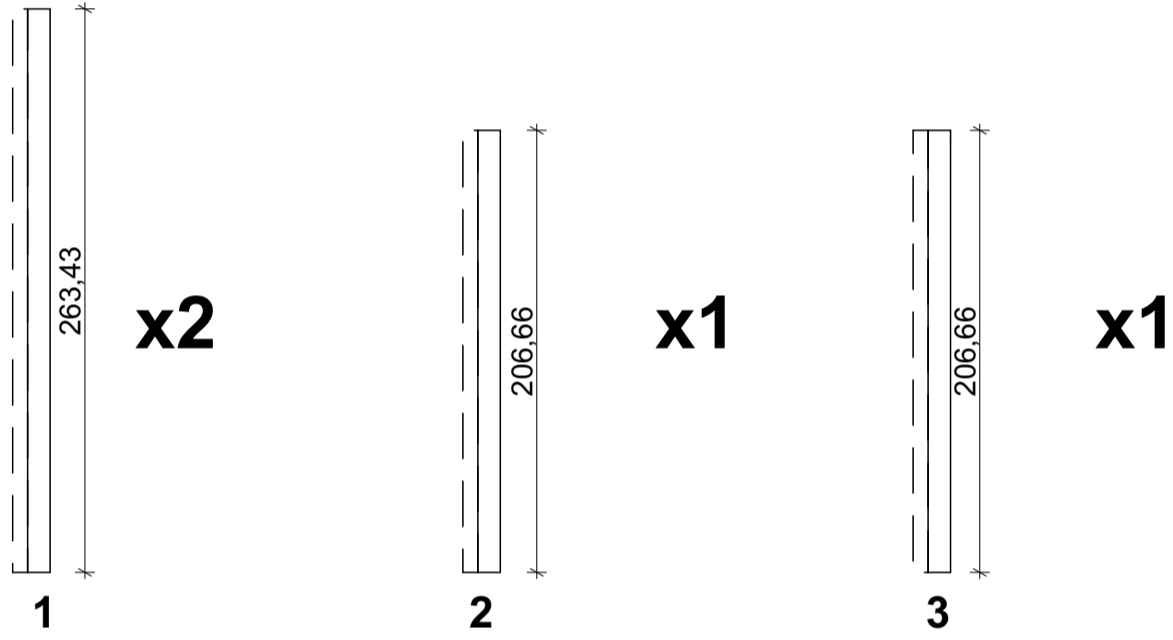
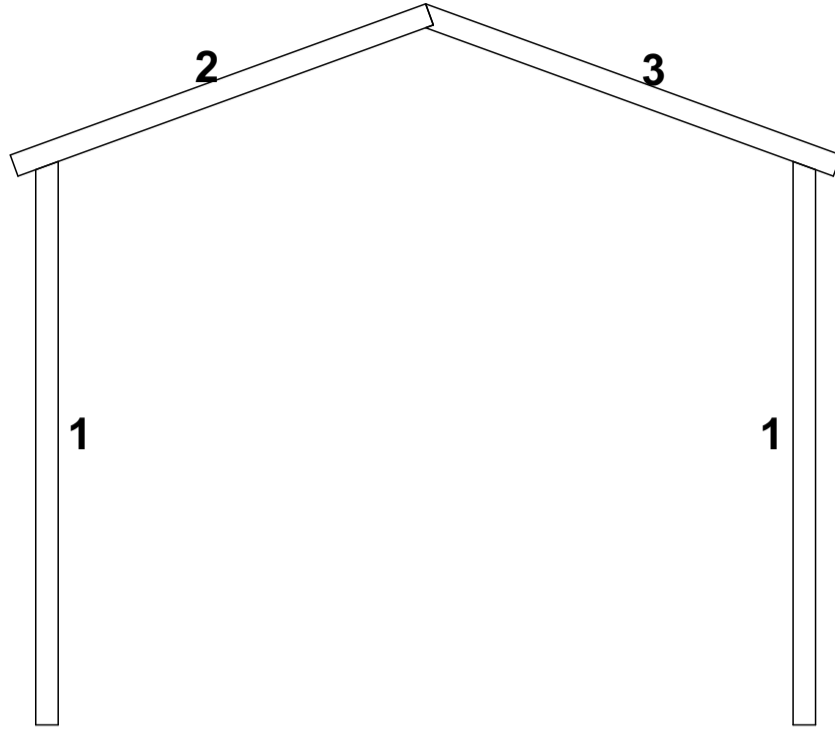

Sac L Profil Kaplama (Ön Cephe)
10cm x 10cm

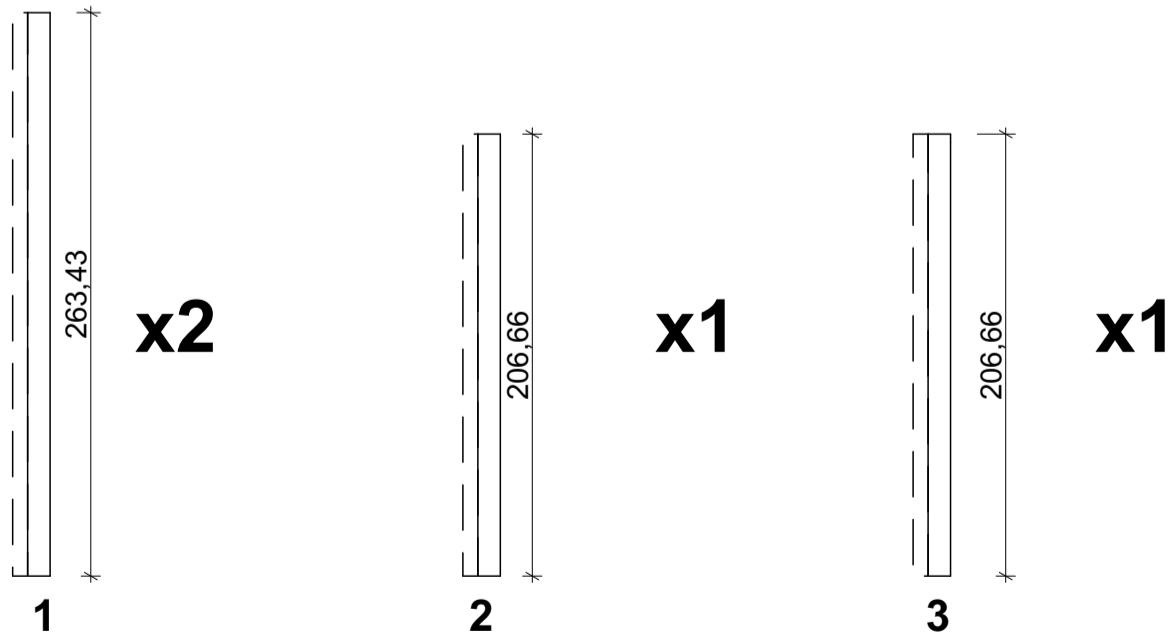

Sac L Profil Kaplama (Arka Cephe)
10cm x 10cm

Taşıünü 70 kg/m³

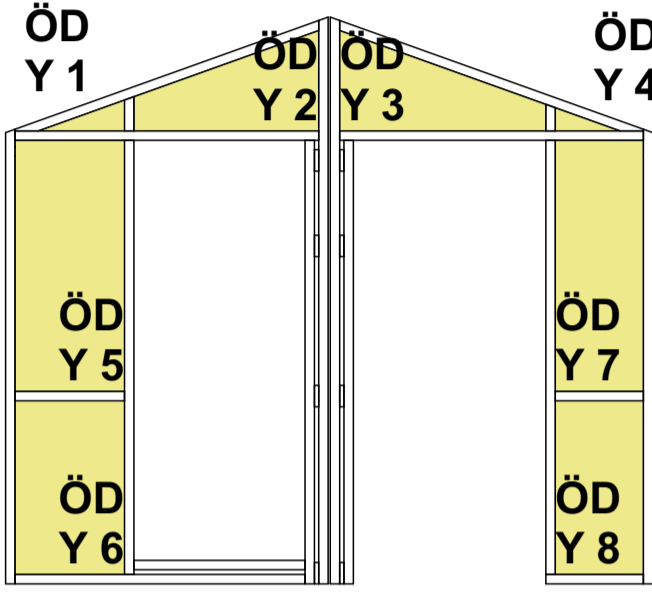

ÖN DUVAR
Dıştan Görünüş

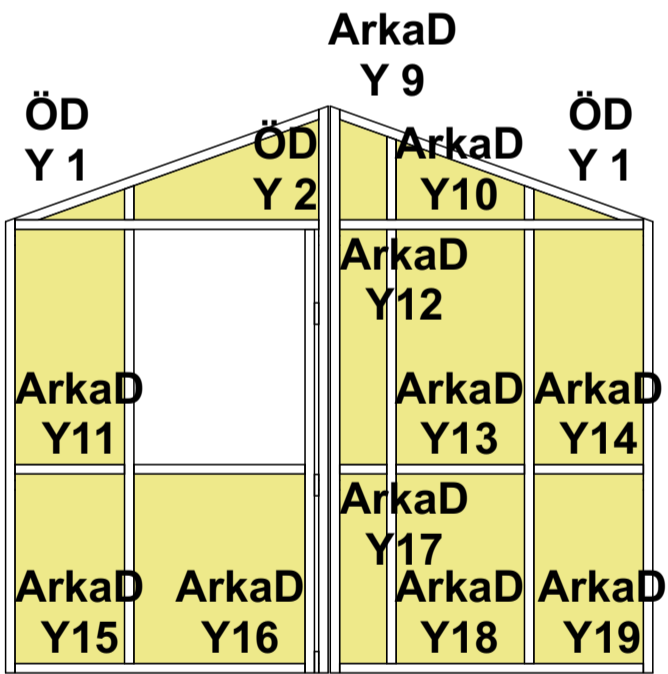
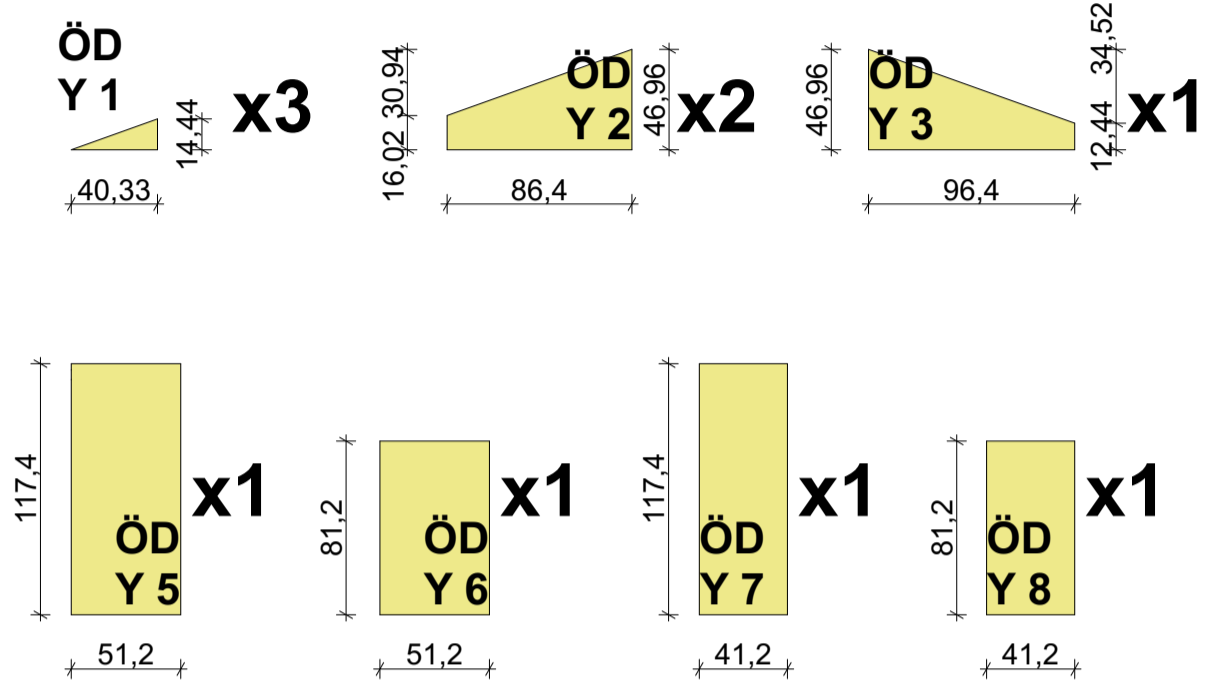

ARKA DUVAR
Dıştan Görünüş

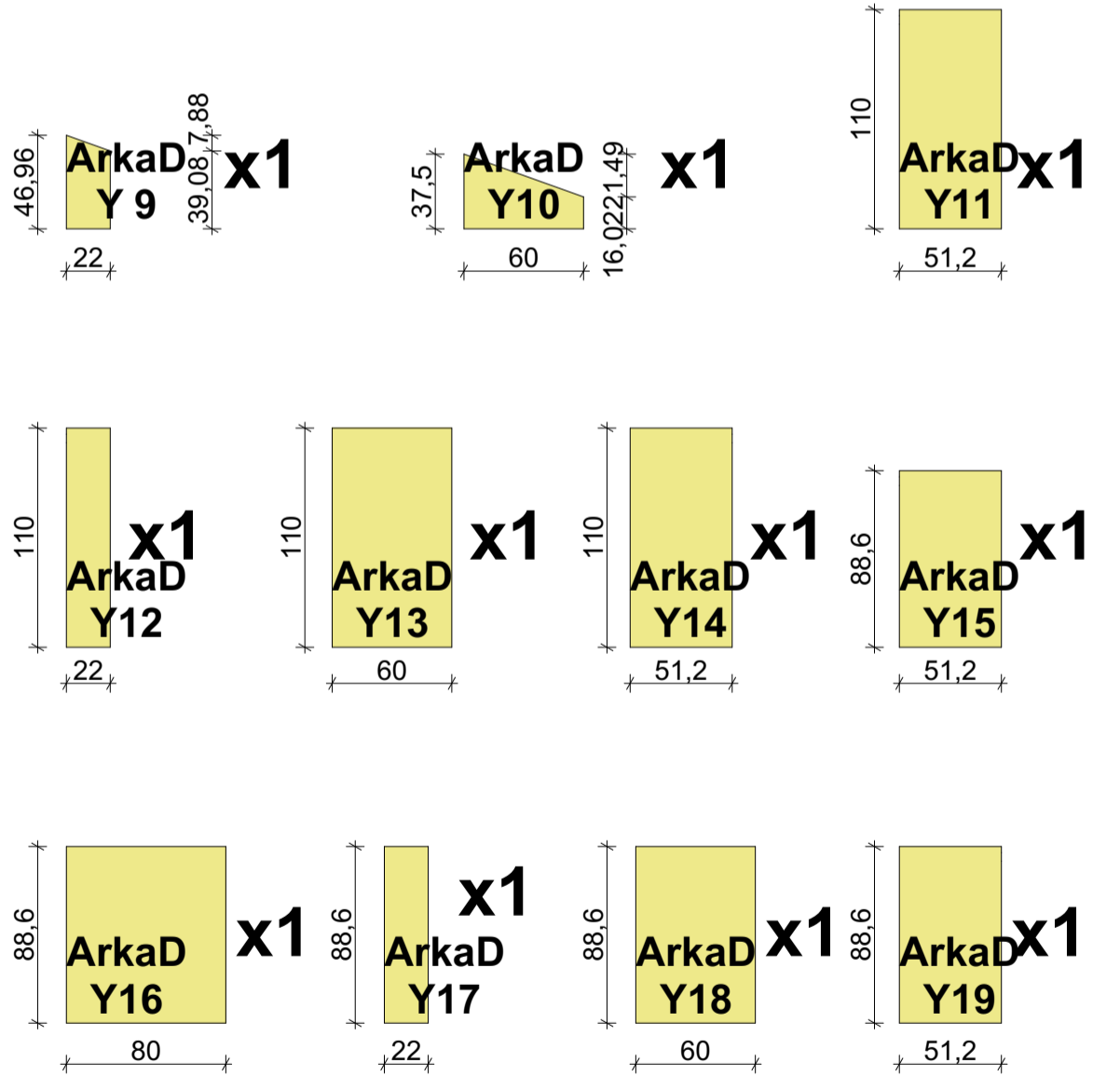

Taşıünü (Ön Duvar) Alan:	2,44 m ²
Taşıünü (Arka Duvar) Alan:	4,96 m ²

YALITIM METRAJI

TAŞYÜNÜ

Zemin Alan:	19,90 m ²
Ön Duvar Alan:	2,44 m ²
Arka Duvar Alan:	4,96 m ²
Toplam Alan:	27,30 m²

SU YALITIM

Duvar ve Taşıyıcılar (Arka Cephe):	9,46 m ²
Duvar ve Taşıyıcılar (Ön Cephe):	7,14 m ²
Lambri Alan:	2,40 m ²
Yan Duvarlar Alan:	3,39 m ²
Tavan Alan:	2,58 m ²
Toplam Su Yalıtım Alan:	24,97 m²

NEM BARIYERİ

Toplam Alan:	897,22cm x 886,60cm = 79,55 m²
---------------------	--

TAŞIYICI ELEMANLAR

OSB Kenet Sistemi (Taşıyıcı Modül) Yerleşim Planı

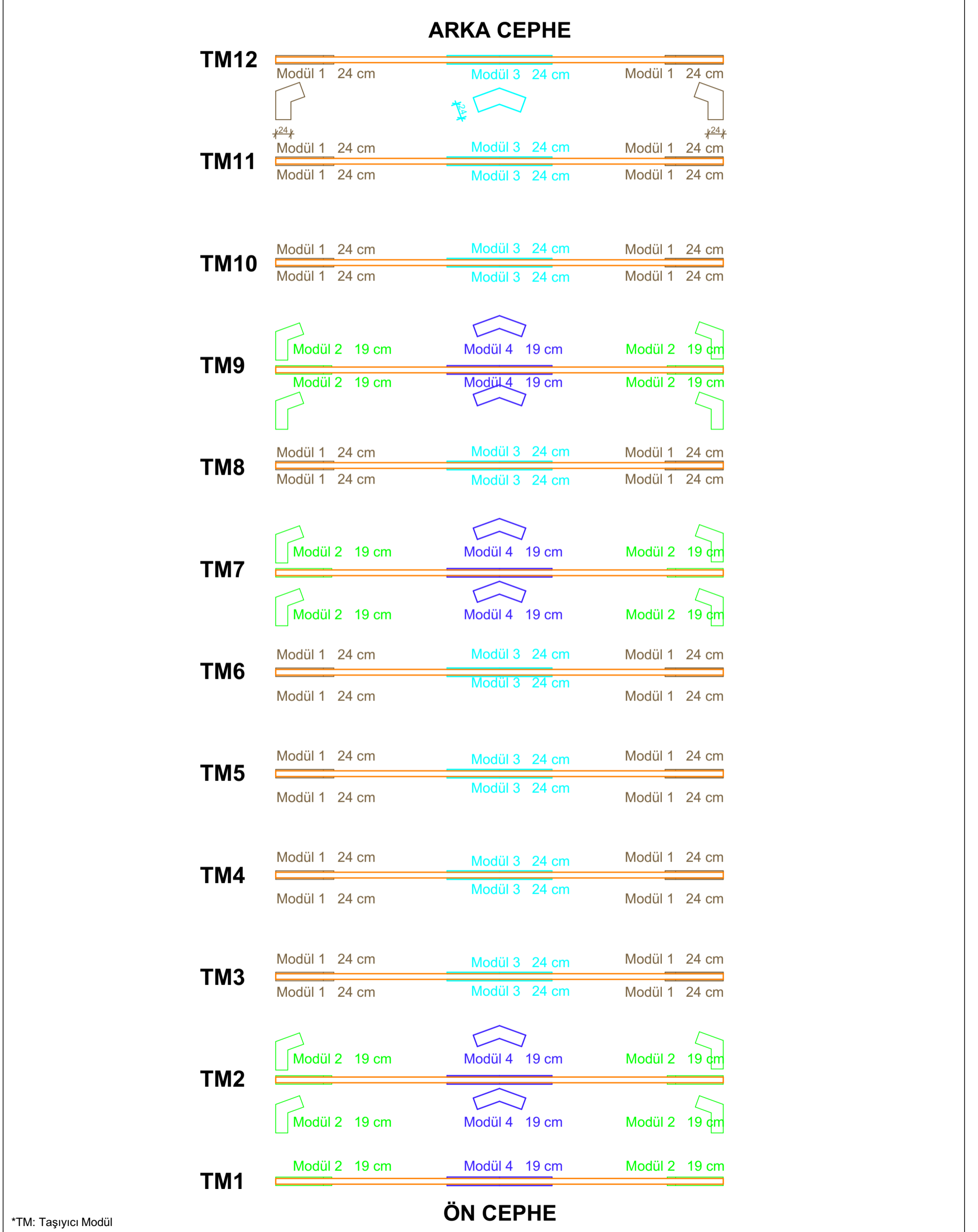

TAŞIYICI ELEMANLAR

Taşıyıcı OSB Parçalar (Ön Duvar Önü ve Arka Duvar Arkası)

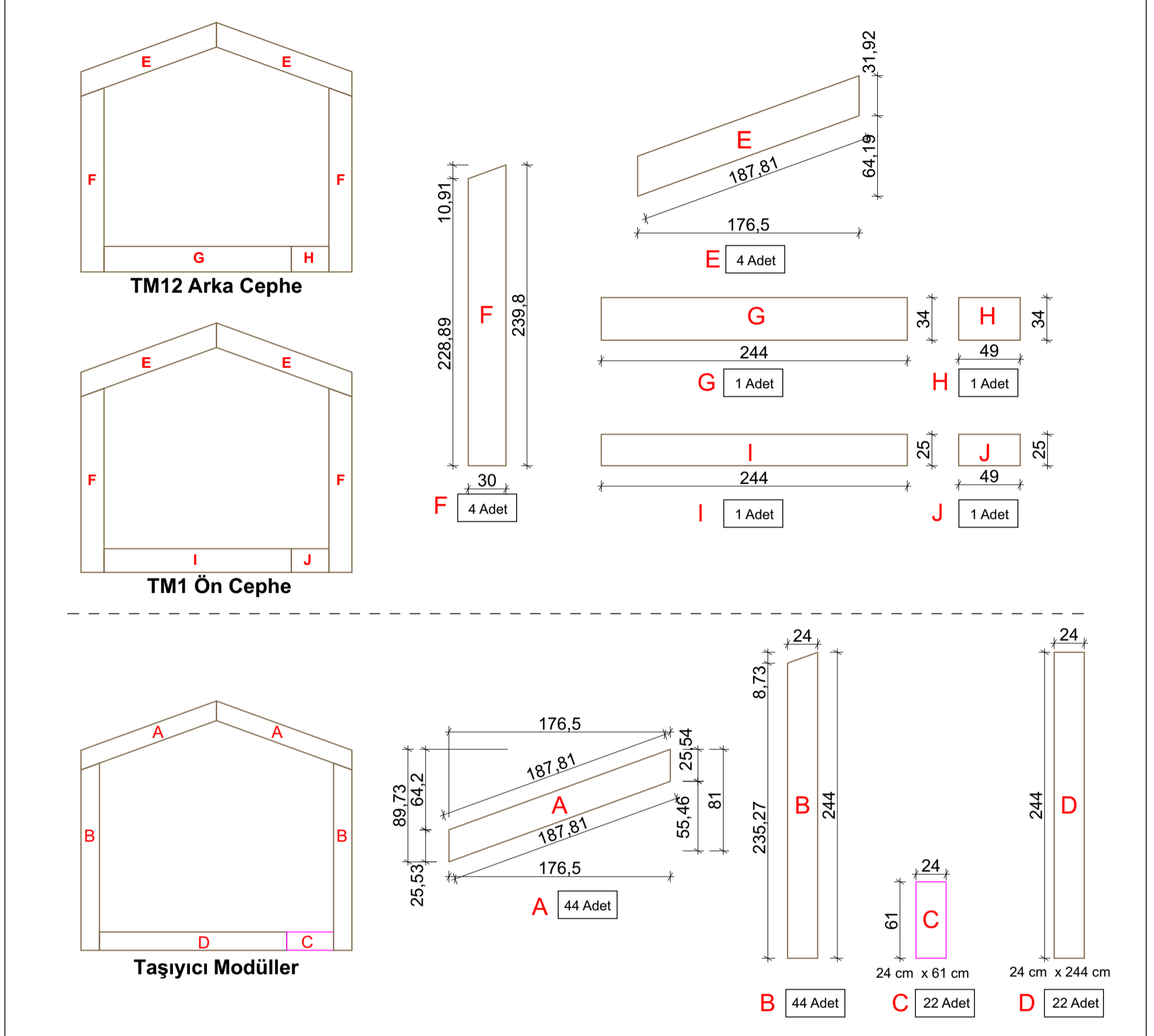

OSB Modülleri

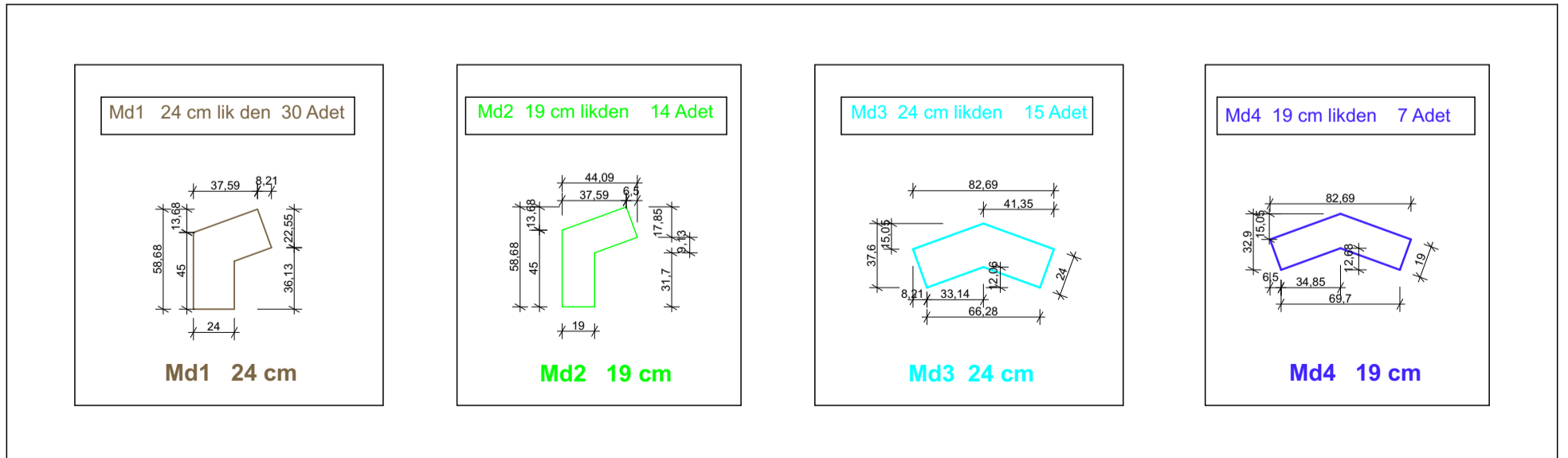

TAŞIYICI ELEMANLAR

Taşıyıcı Modüldeki Karkas Adeti ve Kesim Şablonu

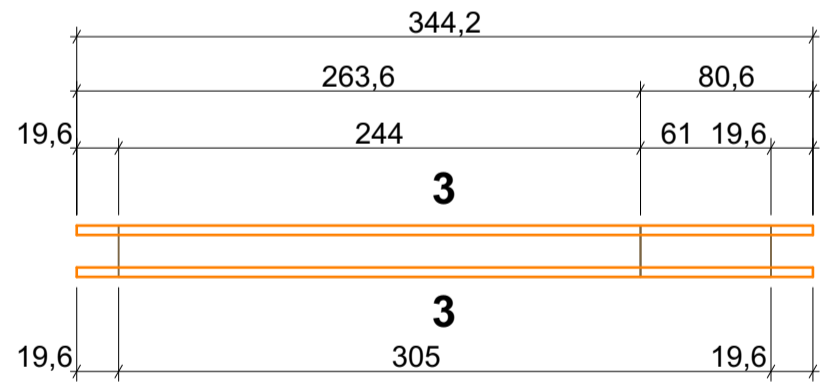
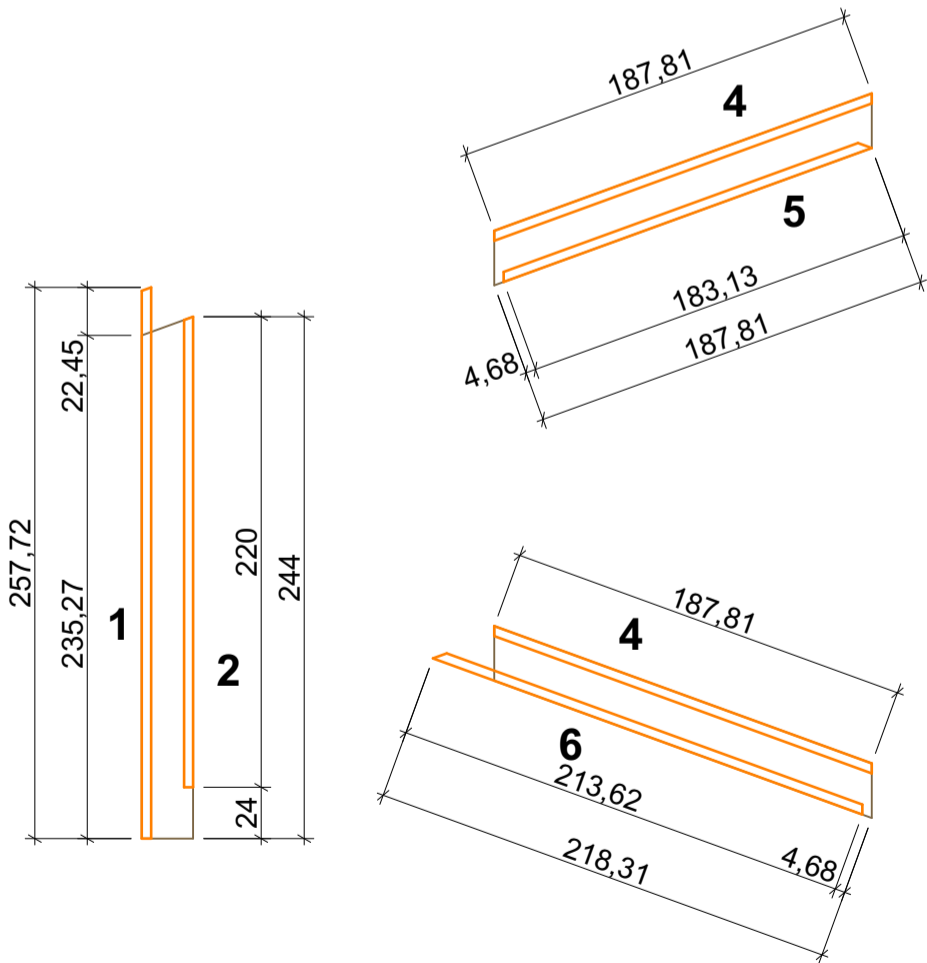
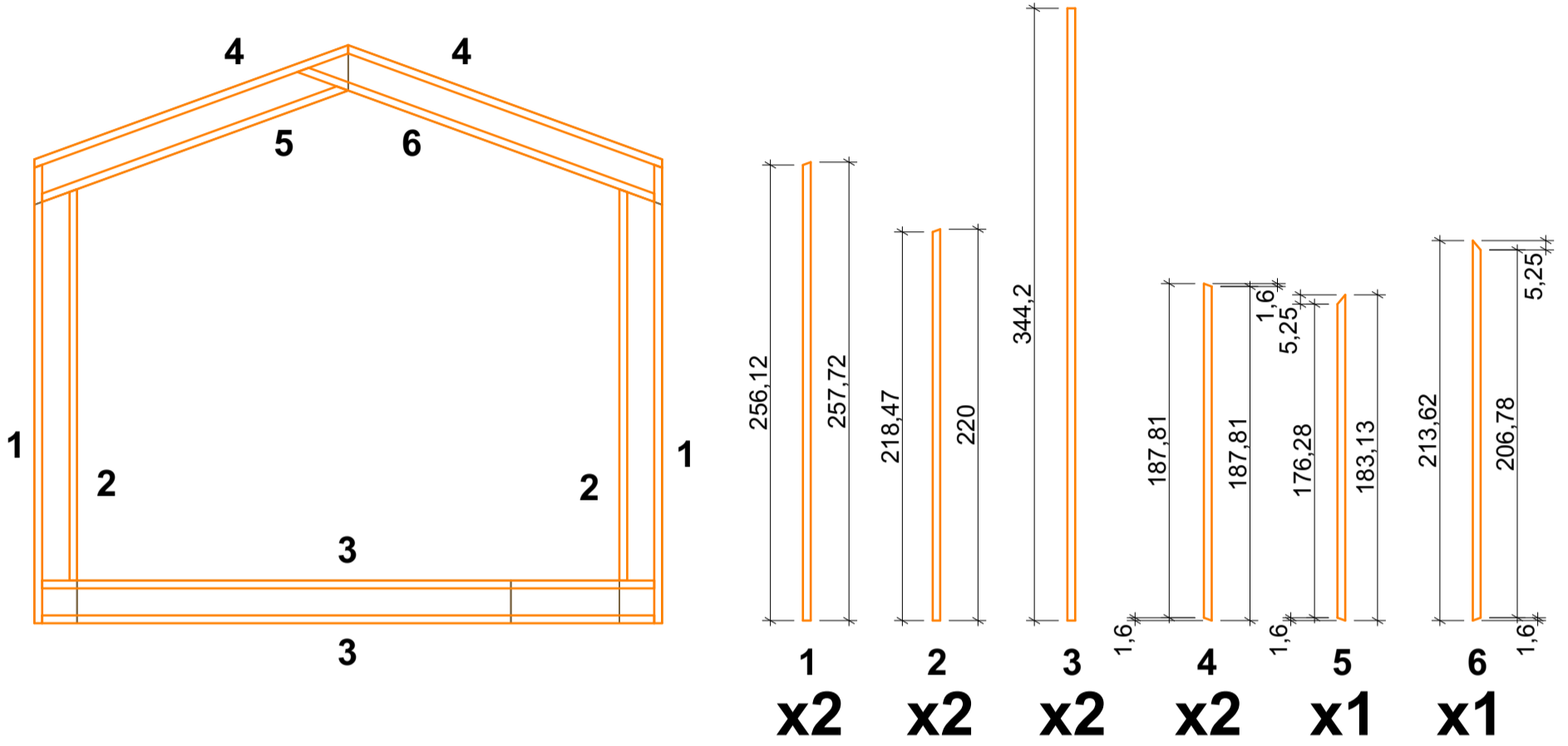

Ahşap Karkas kesim listesi (Toplam)

- | | |
|----------|----------------------|
| 1 | 257,7 cm den 24 Adet |
| 2 | 220 cm den 24 Adet |
| 3 | 344 cm den 24 Adet |
| 4 | 189,4 cm den 24 Adet |
| 5 | 183 cm den 12 Adet |
| 6 | 213,6 cm den 12 Adet |